

THE RESTORATION OF ECOLOGICAL  
CONTINUITY CORRIDORS ON MOTORWAYS

JUNE 2016



SUMMARY REPORT  
Feedback on wildlife  
structures and  
monitoring in the  
VINCI Autoroutes network

## ACKNOWLEDGEMENTS

VINCI Autoroutes would like to thank all of its partners who participated in this endeavour. Their work made this feedback report possible. 17 different structures collected the monitoring data that formed the basis of this report.

- LPO France (Sylvain Fagart, Philippe Jourde, Gwenael Quintenne, Thierry Micol);
- Charente-Maritime Regional Hunters' Federation (David Marc, François Rodriguez);
- LPO Drôme (Sébastien Blache, Alexandre Movia, Stéphane Vincent);
- Drôme Regional Hunters' Federation (Jérôme Guilloud, Christophe Mathez);
- Drôme Fishing and Aquatic Environment Protection Federation (Yann Monnier);
- FRAPNA Loire (Mélanie Higoa, André Ulmer);
- Loire Regional Hunters' Federation (Pierre Barrellon Franck Vital);
- FRAPNA Rhône (Julien Bouniol);
- Rhône Regional Hunters' Federation (François Bride);
- Cistude Nature (Christophe Coïc, Thomas Ruys);
- Naturalia Environnement (Benjamin Allegrini, Baptiste Dolidon, Eric Durand);
- Les écologistes de l'Euzière (Damien Ivanez, Clément Lemarchand, Jean-Paul Salasse);
- The Cofiroute Environmental Officers (Fanny Bernard-Guerassimoff, Didier Elie, Sylvain Joursand, Patrick Menar, Florence Perron);
- Nature Midi-Pyrénées (Emmanuelle Jacquot, Aurélie Nars);
- Biotope (Thomas Menu);
- Le CEN PACA (Antoine Catard, Muriel Gervais);
- L'ONCFS Rhône-Alpes/PACA/Corsica (Jean-Charles GAUDIN, Jean-Pierre SERRES).



### Authors:

Sylvain Fagart<sup>1</sup>,  
Gwenael Quintenne<sup>1</sup>,  
Cédric Heurtebise<sup>2</sup>,  
Philippe Chavaren<sup>2</sup>.

### with the participation of

Michel Galet<sup>4</sup>,  
Jean-Luc Dumas<sup>5</sup>,  
Thierry Micol<sup>1</sup>,  
Éric Guinard<sup>3</sup>,  
Géraldine Audié-Liébert<sup>3</sup>.

Cover photograph: © Emmanuel Rondeau.

<sup>1</sup> LPO France,

<sup>2</sup> VINCI Autoroutes, ASF network,

<sup>3</sup> CEREMA,

<sup>4</sup> VINCI Autoroutes, Cofiroute network,

<sup>5</sup> VINCI Autoroutes Escota network.



## DISCLAIMER

This summary report makes reference to a detailed report entitled "The Restoration of ecological continuity corridors on motorways. Feedback from the wildlife structures and monitoring in the VINCI Autoroutes network".

This summary report does not claim to provide details on specific procedures, rather, it presents feedback from an operator and its partners. It is therefore not intended to be a guide such as those provided by Cerema or found in other institutional publications.

It was compiled based on monitoring that took place between 18 February 2011 and 29 April 2015. Because the monitoring techniques used were constantly developing, its content is subject to revision in the future.

*\*: Asterisks in the text refer to the definition of the associated word in the glossary found at the end of the document.*



European otter with its 3 pups in an wildlife tunnel measuring 120cm. (© LPO France, VINCI Autoroutes).

“  
Advancing  
knowledge  
in road ecology.  
”

Over the past 40 years, great advances have been made in ecological knowledge and the responses to road ecology challenges. Wildlife crossings are being improved through new experiences as they continue to develop with each new motorway.

And yet feedback from this long-term monitoring is rarely presented. This is one of the paradoxes of road ecology: considerable sums of money are invested in the work of defragmentation, without there being a careful assessment of the projects' effectiveness. From the initial project for a motorway to its completion, the assessment of fauna passages remains a weak point needing reinforcement, in order to better meet this objective with the best means possible.

The aim of reclaiming Green and Blue Networks is now integrated into new projects (corridor conservation) and is being implemented into the old motorway network (restoration of interrupted networks). The unique nature of this work (the report and summary) lies in the feedback provided from a very recent motorway (A89) as well as the improvement of ecological transparency in the largest French motorway network, in the context of an adapted procedure: the Green Motorway Package (*le Paquet Vert Autoroutier* - PVA), which includes a "biodiversity" component aimed at repairing the ecological disturbances caused by motorways in service.

There are two remarkable aspects to this VINCI Autoroutes initiative:

- it is the first time that feedback has been provided on the modification of existing infrastructure. The assessment involves an impressive amount of developments that promote species diversity, in complex conditions, including both terrestrial and aquatic environments. VINCI Autoroutes explores new techniques, makes assessments, learns from the conclusions, makes adjustments, etc. The motorway operator is implementing a restorative ecology approach that integrates both scientific and operational considerations;
- the majority of this unprecedented work is devoted to assessing the wildlife structures implemented on the A89 motorway and as part of the PVA\* measures. It is worth emphasizing how rare this endeavour is: among the grey literature\* and, to an even greater extent, the scientific literature, little assessment is made of the efficiency of these structures.

This publication gathers and compares very different experiences. A significant amount of fauna restoration has been assessed using both conventional and state-of-the-art techniques, such as thermographic cameras and vibration traps. These experiments took place in unprecedented conditions in terms of observer impacts, through a wide variety of monitoring methods applied to different taxons\* or taxonomic groups, during exceptional observation periods. The monitoring includes new structures (wildlife overpasses, wildlife underpasses, fish passages) and the modification of existing structures (culvert walkways or corbels in hydraulic structures). The authors make a distinction between long-term and short-term monitoring. They suggest that monitoring

procedures should be standardised, and recommend the restoration of track traps, which were too quickly replaced by photographic traps, the benefits and limitations of which they present.

The feedback report calls into question certain environmental engineering practices that are based on weak observations. It confirms the use of wildlife overpasses as habitats and corridors for small mammals, as well as the beneficial role of windrows. It confirmed that bats regularly make use of culverts. This use is linked to their size, accessibility, and position in relation to interrupted corridors. Each type of structure offers characteristics that are best adapted to certain species. Less demanding taxons\* use a wide range of crossings, while others are more selective. There is also reference to interspecific competition.

This feedback report promotes the advancement of knowledge in road ecology and provides perspective for certain recommendations. We can draw many practical conclusions from this report on the effectiveness of the structures, wildlife behaviour, monitoring methods and tools, and shortcomings that need addressing.

Going beyond the raw data and analysis, the authors, who are ecologists and developers by trade and are actively involved in creating wildlife crossings, were able to mobilise and bring to light an exceptional number of observations that had never before been compiled at this level in France. Restoring connections through old infrastructures marked by their history, and subject to significant constraints requires diligence, willpower, patience and the ability to innovate. This type of restorative ecology is like an art form drawing on science and rigour, involving various disciplines and mobilizing a wide range of participants.

This work, the result of six years of design, implementation and assessment provides valuable recommendations on new projects and adaptations of existing structures. It draws together and compares very different experiences, suggests improvements, offers practical recommendations, guidelines for use, techniques, and assessment protocols. The quality of this publication makes it a reference in the field of road ecology.

Jean Carsignol,  
*Specialist in road ecology,  
Research Director with Cerema*

# CONTENTS



“ A reference in the field  
of road ecology.

*Jean Carsignol.* ”



<b>CONTEXT &amp; HISTORY</b>	<b>6</b>
CONTEXT	6
WILDLIFE MONITORING HISTORY WITHIN TRANSPORT INFRASTRUCTURE NETWORKS	7
<b>METHODOLOGY IN THE CHOICE OF SITES AND STRUCTURES</b>	<b>8</b>
IDENTIFICATION OF THE ISSUES AND PRIORITIZATION	8
ADAPTING THE STRUCTURES TO THE ISSUES	9
<b>BUILDING &amp; MONITORING THE STRUCTURES</b>	<b>12</b>
STRUCTURE SIZE CALCULATIONS AND BUILDING PRINCIPLES	12
THE CHOICE OF THE MONITORING METHOD	16
MONITORING RESULTS AND CONCLUSIONS	18
<b>SUMMARY OF MONITORING PROTOCOLS BASED ON THE GROUPS OF SPECIES</b>	<b>27</b>
TECHNICAL DATA SHEET 1 <b>GENERAL MONITORING OF MAMMALS USING CAMERA TRAPS</b>	28
TECHNICAL DATA SHEET 2 <b>MONITORING SMALL MAMMALS</b>	30
TECHNICAL DATA SHEET 3 <b>MONITORING HERPETOFAUNA (AMPHIBIANS AND REPTILES)</b>	31
TECHNICAL DATA SHEET 4 <b>MONITORING BATS</b>	32
<b>ANNEXES</b>	<b>33</b>
METHODOLOGY SHEET 1 <b>WILDLIFE UNDERPASS</b>	34
METHODOLOGY SHEET 2 <b>WILDLIFE OVERPASS</b>	40
METHODOLOGY SHEET 3 <b>CULVERT WALKWAY/CORBEL</b>	48
<b>GLOSSARY</b>	<b>55</b>
<b>REFERENCE DOCUMENTS</b>	<b>56</b>

“  
All in all, 81 structures  
were the focus of  
wildlife monitoring.  
”

# CONTEXT & HISTORY

## Context

Since the 1960s, France has considerably developed its land transport infrastructures. The impact this development has had on biodiversity has led to measures promoting biodiversity (Green and Blue networks, Grenelle Environment, National Action Plan) and increased environmental demands.

The motorway as a linear infrastructure, a very visible and easily understood concept in the territory, cristalizes fragmentation problems. In the readaptation of structures, this strong visibility in the landscape represents a good starting point in the effort to restore ecological corridors. The motorway developer VINCI Autoroutes has leverage that is territory-wide, giving it the potential to “unlock” certain barrier effects that have been clearly identified by the stakeholders involved. Therefore, certain structures presented in this feedback are part of the Action Plans for the Regional Ecological Coherence Schemes (SRCE\*) and led to a synergetic undertaking involving several stakeholders.

Due to its long-term role as a developer/operator, the concessionnaire is able to carry out preliminary studies, build a structure, and monitor it over time. This feature is even more significant when it comes to implementing rigorous monitoring programmes, sometimes over long periods of time.

The feedback is based on two complementary endeavours, the Green Motorway Package and the A89 roadwork:

- the PVA\* is an economic stimulus plan undertaken with the State between 2010 and 2013. Significant investments were made in various environmental aspects: noise level reduction, the protection of water resources, and biodiversity conservation. This endeavour was aimed at modernizing existing road infrastructures by environmentally readapting them. 38 structures were developed under this plan, creating ecological reconnections throughout 13 French departments and 12 different operational motorways;
- roadwork on the last segment of the A89 motorway, between Balbigny (Loire) and La Tour de Salvagny (Rhône), between 2008 and 2013, which completed the motorway connection between Bordeaux and Lyon. The work complies with recent environmental standards, and included 55 ecological reconnection structures.

All in all, 81 structures (66 of the previously cited 93 structures, to which 15 structures were added that are not dedicated to wildlife) were the focus of wildlife monitoring aimed at assessing their use by wildlife. This monitoring was carried out by 17 different local organizations (associations, research units, etc.) and

\* see Glossary, page 55





Photos n°1: **Silver process camera trap used in the 1990s.**  
(© VINCI Autoroutes, OGE)



Photos n°2: **Compact and high-performance camera trap used since 2011.** (© VINCI Autoroutes, LPO France)

represented an unparalleled batch of data in the area of wildlife monitoring on motorways in France (approximately 25,000 crossing data gathered via camera traps from over 1,280 months of monitoring). This created a desire to pool the insights gained in order to promote the advancement of knowledge in an area that is still incomplete.

## Wildlife monitoring history within transport infrastructure networks

Wildlife monitoring has been carried out for over 40 years with the aim of assessing the use of different types of structures for different groups of species. Today, the monitoring of wildlife crossing structures is an integral part of impact studies (Article R. 122-5 paragraph 7 of Decree n°2011-2019 of 29 December 2011 reforming impact studies) and is included in some of the objectives clearly stated in the Action Plans for the Regional Ecological Coherence Schemes.

While the initial monitoring was primarily focused on game species, today habitat fragmentation issues and the subdivision of populations also affect other taxonomic

groups, such as small mammals, insects, amphibians, reptiles and bats.

In general, the monitoring of motorway structures is currently conducted using inventory tools adapted to each taxon\*, by adopting a protocol that reveals whether or not wildlife cross the structures. Over the past ten years, significant technological progress in the area of monitoring materials has enabled the widespread use of relatively effective tools such as camera traps and ultrasonic recording. These tools have made it possible to effectively and autonomously collect data that is more precise over longer monitoring periods.



# METHODOLOGY IN THE CHOICE OF SITES AND STRUCTURES

## Identification of the issues and prioritization

This feedback report presents the operating method chosen for identifying the intervention sites. It reiterates the need to coordinate efforts, to work towards coherency with the other planning documents, and the value of multi-criteria analysis for shared and constructive territory projects.

### **IDENTIFYING THE NEEDS**

There are several essential steps for determining the issues with the aim of identifying needs:

- large scale (national/regional) spatial analysis based on landscape ecology that incorporates the total available cartographic data (SRCE mapping, CARMEN\* database, etc.);
- environmental field expertise over a period of time that is long enough to face local challenges, in particular for target species:
  - evaluate the structural ecological continuity corridors (operational / in need of restoration) previously selected based on mapping and ecological landscape analysis,

- identify the barrier effects and the cumulative effects,
- study the current use of existing crossing structures (hydraulic structures, road structures, combined crossings and crossings dedicated specifically to wildlife).

Following these steps, an initial prioritization within the areas lacking operational structures can be established based on ecological criteria, identifying the sites that require attention. Among the sites identified as “requiring attention”, experts will seek to establish the initial condition, which is a necessity in planning for the potential worksite (regulatory requirements, the worksite’s environmental responsibility). This will also provide the initial state required for post-development monitoring.

At this stage, this first prioritization should not take technical constraints into account, in order to avoid influencing the analysis. The goal is to find sites requiring ecological restoration, not to find sites where developments are feasible.

### **Ensuring the sustainability, feasibility and local acceptance of the project. Here too, several steps are necessary prior to the feasibility studies:**

- check the project’s sustainability (in terms of maintaining the natural characteristics of the surrounding habitats), particularly by referring to planning documents (SRCE, SCoT\*, PLU/PLUi\*, etc.);

\* see Glossary, page 55



Photo n°3: **View of a wildlife overpass.** (@ L'Annexe, VINCI Autoroutes)

- check the technical prerequisites (sufficient back-fill for underpasses, land available or excavation for overpasses, the dimensions of a hydraulic structure for equipment, etc.) that will orient the choice between creating a structure (overpass, wildlife tunnel) and adapting existing structures (culvert walkway, fish passage on a threshold, etc.);
- consultation with various stakeholders in the territory for the acceptability of the project (in the areas of agriculture, forestry, hunting, fishing, and other managers of nearby infrastructure, etc.), in order to potentially initiate collaboration (joint action);
- assess compatibility of the cost of the operation with the available budget;
- assess compatibility of the timetable for completion with the deadlines.

The prioritization of projects is based on multi-criteria analysis combining each of the factors mentioned above, enabling to project to be selected based on a sum of criteria. Each project is then studied to assess its technical feasibility.







It is interesting to note that one of the limiting factors (apart from budgetary considerations) was the existence of cumulative barrier effects causing projects involving several developers to be eliminated, deemed incompatible with the timeframe for completion.

## Adapting the structures to the issues

Based on the species, the different types of structures (*Table n°1, page 10*) are found to be more or less functional. In general, the larger the dimensions of a structure, the greater the number of species that are able to use it. Large wildlife like the red deer (*Cervus elaphus*) therefore play the role of an “umbrella” species. However, in terms of the overall population of the smallest species, an increase in the number of small and medium-sized structures sometimes proves to be better adapted than one large structure. Some structures are specialized and intended for specific species (even though they allow other species to cross as well), such as amphibian crossings or dry land crossings for semi-aquatic mustelids.

Many solutions exist, yet budgetary and technical constraints, or simply an unusual configuration can lead to the choice of a more simple structure, or a default or experimental type of structure. Collaborative work between partners is therefore advantageous for pragmatically formulating a position (considering the limited availability of knowledge) and testing certain structure types.

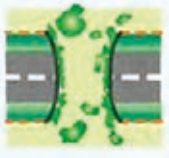
Table n°1: **Classification by structure type according to the classification established by SETRA.**  
 (source: figures from the SETRA technical guide, 2005)

Descriptive image	Description of the structure type
	<b>Type I:</b> Culvert or scupper.
	<b>Type II:</b> Amphibian tunnels.
	<b>Type III:</b> Small combined hydraulic passages. <ul style="list-style-type: none"> <li><b>a:</b> Small hydraulic structure with submersible dry land.</li> <li><b>b:</b> Hydraulic structure with narrow dry land.</li> <li><b>c:</b> Medium-sized hydraulic structure with dry land 1.5m above.</li> <li><b>d:</b> Large hydraulic structure that can be used by large and small animals.</li> <li><b>e:</b> Dry pipe located near the hydraulic structure.</li> </ul>
	<b>Type IV:</b> Small forest or agricultural passage.
	<b>Type V:</b> Underpass for large animals.
	<b>Type VI:</b> Wildlife overpass, green bridge, plant-covered bridge.
	<b>Type VII:</b> Viaduct as an underpass.
	<b>Type VIII:</b> Ecological corridor (tunnel).

\* see Glossary page 55



Photo n°4: **3 types of structures that restore ecological continuity: wildlife underpass, culvert walkways, and a corbel (left to right).** (© VINCI Autoroutes, L'Annexe)

Some of the monitoring in this summary focused on combined road-fauna structures and structures that were not specifically dedicated to fauna (hydraulic structures, agricultural/forest passages) but that seemed suitable for the passage of fauna. With the objective of comparing all the monitoring data in the clearest way possible, certain SETRA classification categories were combined to create 6 major structure categories:

- dry culverts (types I and III), hereafter referred to as wildlife underpasses\*;
- hydraulic structures designed using culvert walkways\* or corbels\* (types IIIa, b, c, d);
- wildlife overpasses\* (type VI);
- underpasses specifically for large animals (type V);
- road structures adapted for fauna (combined fauna-road structures, type IV);
- hydraulic, agricultural and forest passages not dedicated to fauna (that fit the dimensions of types I and IV).



\* see Glossary page 55

# BUILDING & MONITORING THE STRUCTURES



## Structure size calculations and building principles

Using methodology sheets (*Annexes, page 33*), this feedback report presents the dimensioning principles adopted for the following types of structures: wildlife overpasses\*, wildlife underpasses\*, corbels\* and culvert walkways\*. Regarding the dimensions for fish passages, please refer to the SETRA information note n°96 (small hydraulic structures and ecological continuity. The case of fish fauna, 2013) as well as the ONEMA\* guide (Information on Ecological Continuity ICE, 2014).

The choice of measures for motorway construction necessarily includes maximum security, strict adherence to the regulations governing road structures (Eurocodes\*, etc.), compliance with the concession's specified requirements, and the objective of long-term sustainability that excludes some less sustainable solutions.

This combines ecological engineering with civil engineering and ecological expertise.

The use of structures by fauna depends on a multitude of "details": design and construction of the entrances for fauna, creating connections with the fences that are sealed as much as possible, verifying that small mesh lining is correctly fixed, etc.

As well as the dimensioning principles, the feedback also shows the developments that have taken place

since the structures became operational. In order to better implement the monitoring that takes place post-construction (optimizing data collection capacity), this parameter must be anticipated and incorporated into the design stage in the treatment of the structure (installing brackets for camera traps for example).

### ECOLOGICAL DECK CONSTRUCTION

With regard to **wildlife overpasses**, the deck construction process represents an important factor in ensuring the project's success.

It is particularly important to juxtapose a wide variety of micro-environments that encourage many different biological groups to cross the overpasses.

The weight of the soil on the deck was optimized for technical reasons (soil loads calculated with the mass density of 20.0 kN/m<sup>3</sup>), but also for reasons relating to the management of the environment. The thickness of the soil on the deck varies from 30 cm in the central section for the herbaceous plants, to 90 cm on the banks for the wooded strips. This layout, in addition to limiting the development of ligneous plants, is beneficial for monitoring, since it limits the growth of herbaceous plants, through the summertime stresses, that could potentially interfere with the camera traps' detection systems. The addition of sand or gravel in strips or mixed with soil can complete the layout by keeping the areas open and contributing to the diversity of the ecological niches.

\* see Glossary, page 55



Photo n°5: **An operational wildlife overpass, developed for all fauna groups (small\*, medium\* and large fauna\*).**  
 (@ Olya, VINCI Autoroutes)



Photos n°6: **Wildlife overpass in construction phase (left), and three years after it became operational (right).** (@ VINCI Autoroutes)

### **SPECIFIC CONDITIONS FOR PHOTOGRAPHICALLY MONITORING WILDLIFE OVERPASSES**

Monitoring large animals with infrared camera traps is limited by the range of the camera's flash (visibility for night photographs) and by the sensor, both of which vary depending on the model of the camera trap and the size of the animals detected. With a width of up to 8 m, a large animal passage can be monitored with only one camera. From a width of 8 to 15 m, two camera traps are required, one opposite the passage and one perpendicular to the centre line of the overpass. For greater widths, the addition of cameras in the central section requires mounting systems to be anticipated, such as large stone blocks. The addition of a central pond is a possible technique and can effectively force animals to pass closer to the cameras.

The creation of a windrow adds a crossing corridor and implies the addition of a camera trap for small animals.



Photo n°7: **A wildlife underpass (dry culvert with soil cover) near a hydraulic structure.**  
(© VINCI Autoroutes).

**Wildlife underpasses** feature masonry headwalls that on one hand are used to anchor them into the embankment and contain the soil (a funnel-shaped guiding structure is preferred), and on the other hand to provide an optimal connection with the fencing that is reinforced with small fauna mesh. The headwalls feature a concrete apron covered with at least 15cm of soil. This trapezoidal-shaped apron limits erosion and contains plant growth (only herbaceous plants grow on it) in front of the structure.

The wire mesh reinforcement, with 6.5 × 6.5 mm apertures and a height of 1m, commonly used for amphibians, is semi-buried (30 cm). The installation of this reinforcement is difficult, due to the small mesh that prevents the use of metal clip pliers, requiring the use of ties. Due to the small diameter of the wires (0.7 mm), its lifespan can be impacted by plant growth and other factors (tearing caused by several sources, for example from roebucks rubbing their antlers on the mesh). The use of a double lining composed of 6.5 × 6.5mm mesh sandwiched between the motorway fencing and an additional 25 × 13mm or 25 × 25mm mesh (wire diameter of 2mm) for small animals (hedgehogs, rabbits, hares, foxes, mustelids, etc.) can facilitate the installation and increase the lifespan.

#### SPECIFIC CONDITIONS FOR PHOTOGRAPHICALLY MONITORING WILDLIFE UNDERPASSES

Monitoring this type of structure requires the installation of a camera trap in a location that is accessible for regular data collection and, if possible, is protected from the elements and out of sight of pedestrians. An installation on the ground obstructs an often narrow passage (wildlife tunnels with a diameter ranging from 800 to 1,200mm). Installing a mounting angle on the upper part of the structure (maintaining a 15cm air draught above), 5m inside the tunnel, enables the installation of a camera trap facing the longest side (to better observe fauna crossing and turning back), and allows the trap to be somewhat hidden.

**Corbels** and **culvert walkways** depend on a structure's hydraulic capacity. Only a hydraulic study can reveal this dimension. Neglecting this preliminary step could hinder the fauna's future use of the structure (risk of structures being flooded too frequently). Furthermore, if the design adversely affects the structure's size (raising flood levels, failure to comply with the ordinances of the French Water Authority), the operator will be held liable for hydraulic and



regulatory risks. Setting the standards in terms of water depth/inflow enables a visualisation of the options for the structure's altimeter setting. A setting below Q3\* is often too low, causing the corbels/culvert walkways to be flooded frequently. Often the layout of the motorways allows for a setting between Q3 and Q5, while ensuring that an air draught of 80 cm is maintained above the structure.

The choice between a corbel or a culvert walkway (one or two ledges) and the width (minimum width of 50 cm) can only be made following the hydraulic study, given that the corbel has a lesser impact on the structure's hydraulic capacity and the water drainage factors (water level and velocity).

Ensuring the maintenance of the fish crossing capacity represents an integral part of the study, and is required by law (general provision of the ordinance of 28 November 2007). If the culvert walkway causes the water surface to rise by narrowing the width of the structure, this will also result in increased water velocity, which could potentially prevent fish from crossing.

Calculations must be made in order to ensure that the water draught and velocity, projected in a range between [QMNA<sub>5</sub>\* - 2.5 x Module] (corresponds to approximately 80% of the time), allow the fish species present in the stream or river to cross through the structure (see SETRA note n°96).

Many projects that initially plan for culvert walkways later opt for corbels due to factors involving hydraulic gauging and/or fish crossing. In other cases, the structure's design includes the addition of riffle constructions or deflectors, among other options intended for fish. However, corbels are often narrower than culvert walkways, and it is often more difficult to connect them to the banks upstream and downstream.

Therefore, the continuity objectives of the hydraulic structures must be considered for both terrestrial and aquatic crossings.



Photo n°8: **Connection between the bank and the corbel of a hydraulic structure.** (© Freyssinet).



Photo n°9: **Riffle constructions in a hydraulic structure with a corbel.** (© Freyssinet).



Photo n°10: **A double culvert walkway inside a hydraulic structure.** (© VINCI Autoroutes).

### **SPECIFIC CONDITIONS FOR PHOTOGRAPHICALLY MONITORING HYDRAULIC STRUCTURES**

The monitoring constraints of hydraulic structures vary greatly (dimensions, clear width, materials used for the walls, the structure's access to water, etc.). In general, the monitoring must therefore be dealt with on a case by case basis. As is the case with wildlife tunnels, it is best to install the camera 5 metres inside the structure, facing the longest side. In order to do this, several mounting supports are possible for hanging the camera (mounting angle, articulating arm mount) so as to not prevent animals from passing through a clear width that is often limited (50 cm), and to maintain enough distance so that the crossings may be detected.

\* see Glossary, page 55



“  
The choice of the  
monitoring method must  
be carefully considered.  
”

## The choice of the monitoring method

The choice of the monitoring method must be carefully considered according to the monitoring objectives and the specific structure's characteristics.

The first step is to gather information based on the monitoring objectives:

- **assessment of the structure's use by fauna:** this requires collecting as much data as possible on animal crossings (number of crossings and number of species using the structure);
- **assessment of wildlife behaviour in response to the structure:** in order to assess the animals' behaviour when they come in contact with the structure, devices (camera trap/video) are set up to focus on the aspect to be studied (the structure's entrance, fencing);
- **assessment of a structure's effectiveness:** this point is not developed here, since it is related more to the field of research (population study).

The monitoring objective can be focused on one specific species. In this case, it is important to choose materials that are best suited to detecting the species.

In the second step, the characteristics of the structure to be monitored guide the choice of method. Two main criteria help to pinpoint the constraints involved in the choice of method:

- **the clear width of the structure:** the narrower the passageway of the structure, the easier it will be to monitor. An increase in width can lead, for example, to an increased number of camera traps, the expansion of the track beds, or the inability of the vibration sensor to cover the structure's entire width;
- **underpass or overpass:** the positioning of equipment in an underpass removes many weather-related challenges (precipitation, wind, sun,

significant atmospheric temperature range, etc.). On the other hand, on an overpass (in the open air), the track beds, vibration sensor and, to a lesser extent, the camera trap will all be less effective or even very ineffective.

It is important to choose and clearly define the monitoring methods and materials that will be used before the assessments begin for each type of structure to be studied, by classifying the structures beforehand based on size and the type of species or the group of species they were built for. The monitoring must then be set up in the same way for each structure type and each target species or group of species, without changing the established protocol during the assessment period, until the end of the monitoring period. Strictly adhering to these three conditions will ensure comparisons from several structures over a set period of time that are statistically reliable and meaningful. The results and conclusions of the statistical analysis will be all the more robust and relevant.

*Table n°2, page 17, lists the advantages and disadvantages of each monitoring method.*

Recording the gathered data is crucial and often requires a significant amount of time. It must therefore be optimized from the very beginning according to the monitoring objectives. In addition to the factors that characterize the structures (size, structure type, etc.) and the monitoring (observer impacts, type of materials, etc.), each data item must be entered with a minimum of information: date, time, species, number of members of the species, crossing, behaviour, etc.

It is impossible to plan exactly how much time will be required to enter the data, since the number of crossings varies significantly. As a reference, recording (with the minimum information provided above) 400 to 500 fauna crossings requires approximately 3 hours of work (for someone who is familiar with this task).

Table n°2: **Advantages and disadvantages of the different monitoring methods used.**

	<b>Advantages</b>	<b>Disadvantages</b>
<b>Camera trap (infrared mode)</b>	<ul style="list-style-type: none"> <li>• Significant autonomy</li> <li>• Timestamped data</li> <li>• Customization is possible in certain cases</li> </ul>	<ul style="list-style-type: none"> <li>• Does not detect cold-blooded animals</li> <li>• Can sometimes be intrusive for medium sized animals (foxes, stone marten, etc.)</li> </ul>
<b>Camera trap (minute trigger mode)</b>	<ul style="list-style-type: none"> <li>• Takes automatic samples</li> <li>• Also triggered by infrared</li> <li>• Suited to the slow movements of amphibians</li> </ul>	<ul style="list-style-type: none"> <li>• Reduced autonomy</li> <li>• Not adapted to fast movements</li> <li>• Large amount of photos to verify</li> </ul>
<b>Track beds</b>	<ul style="list-style-type: none"> <li>• The adaptable size of the track bed</li> <li>• Relatively non-intrusive</li> </ul>	<ul style="list-style-type: none"> <li>• Varying readings and interpretations (humidity, substrate) of the tracks (use by wildlife underestimated)</li> <li>• Data not timestamped</li> <li>• Not timestamped</li> <li>• Observer's bias</li> <li>• Regular crossings (time-consuming)</li> </ul>
<b>Vibration sensor</b>	<ul style="list-style-type: none"> <li>• Significant autonomy</li> <li>• Timestamped data</li> <li>• Customization possible in certain cases</li> <li>• Detects cold-blooded animals</li> <li>• Reduced detection bias</li> <li>• Also triggered by infrared sensor</li> </ul>	<ul style="list-style-type: none"> <li>• Limited mat size (~ 1m<sup>2</sup>)</li> <li>• Intrusive for medium-sized animals (Fox, Badger, etc.)</li> <li>• Device ill suited to being exposed outside</li> </ul>
<b>Capture (Mark-Recapture)</b>	<ul style="list-style-type: none"> <li>• Identification and even individualisation</li> <li>• Interpretation of movements when the animal is recaptured</li> </ul>	<ul style="list-style-type: none"> <li>• Very intrusive</li> <li>• No behavioural data</li> <li>• Observer impacts limited over time</li> </ul>
<b>Direct observation</b>	<ul style="list-style-type: none"> <li>• Behavioural data</li> </ul>	<ul style="list-style-type: none"> <li>• Sometimes intrusive</li> <li>• Observer's bias</li> <li>• Time-consuming</li> <li>• Observer impacts limited over time</li> </ul>
<b>Ultrasonic recorder (Bats)</b>	<ul style="list-style-type: none"> <li>• Significant autonomy</li> <li>• Identification is possible</li> </ul>	<ul style="list-style-type: none"> <li>• Flight paths cannot be perceived using only one recorder</li> </ul>
<b>Thermal imaging camera (Bats)</b>	<ul style="list-style-type: none"> <li>• Flight paths perceived</li> <li>• Identification is complicated</li> </ul>	<ul style="list-style-type: none"> <li>• Observer impacts limited over time (requires an operator)</li> </ul>
<b>Flight path tracking (Bats)</b>	<ul style="list-style-type: none"> <li>• Flight paths are perceived</li> <li>• Identification is possible</li> </ul>	<ul style="list-style-type: none"> <li>• Material that has been little used</li> </ul>

## Monitoring results and conclusions



### SIGNIFICANT AMOUNT OF DATA

All in all, 81 motorway structures were monitored. This structure monitoring included 66 structures specifically intended for wildlife and 15 not intend specifically ofr wildlife. The variety of the monitored structures is provided in *Table n°3*.

Table n°3: **Amount and type of structures monitored for the A89 and PVA\***.

Type of structure monitored	A89	PVA
Wildlife tunnel	12	23
Modified hydraulic structure (culvert walkway, corbel)	11	4
Specific large fauna underpass	4	1
Wildlife overpass (new structure or modified structure)	-	4
Combined modified passage	-	3
Fish passage	-	1
Bat bridge	2	-
Bat shelters (viaduct)	-	1
Non-dedicated hydraulic structure	12	-
Non-dedicated underpass/overpass	3	-
Subtotal	44	37
<b>Total</b>	<b>81</b>	

Among these 81 structures, 76 of them, monitored using camera traps, enabled the collection of over 25,000 data between 18/02/2011 and 29/04/2015. The unprecedented scale of this database enabled the calculation of average crossings per year, per structure, and per species. Some of this monitoring, as was the case for the 5 other structures, was carried out and completed using specific wildlife monitoring tools:

- track pads;
- ink beds;
- small mammal capture-mark-recapture;

- amphibian collection/guidance;
- development and testing with vibration sensors (pressure sensors);
- sm2 and anabat sd2 recorders, ultrasonic detectors;
- bat capture using nets;
- daytime/night-time visual survey (avifauna, entomofauna, reptile scales, etc.);
- electrofishing;
- thermal imaging camera.

### MONITORING USING CAMERA TRAPS

All of the monitoring was carried out using infrared camera traps, except in the case of one wildlife tunnel using a "reptile protocol" with a camera trap that was triggered once every minute.

The monitoring of 76 structures using camera traps enabled a minimum of 41 different species to be detected inside the structures (*Table n°4*). These 41 species include 29 mammal species (of which 7 were small mammal species and at least 1 bat species), 4 amphibian species, 4 reptile species and 4 nidifugous bird species\*.



Photo n°11: **European hare entering a wildlife tunnel measuring 120 cm in diameter.** (© VINCI Autoroutes).

\* see Glossary, page 55

**BUILDING AND MONITORING THE STRUCTURES**

Table n°4: List of the species detected (excluding bat species) during the camera trap monitoring, and average number of crossings detected per year and per structure, according to the type of structure.

Vernacular name	Scientific name	Average number of crossings detected per year per structure					
		Wildlife underpasses (n=35)	Modified hydraulic structures (n=14)	Wildlife overpasses (n=4)	Specific large fauna underpass (n=4)	Modified road structures (n=3)	Non-dedicated passageways (n=15)
<b>SMALL, MEDIUM AND LARGE FAUNA</b>		<b>299.4</b>	<b>157.9</b>	<b>608.2</b>	<b>210.1</b>	<b>132.7</b>	<b>176.9</b>
<b>Mammals</b>							
Least weasel	<i>Mustela nivalis</i>	1.6	2.0	-	-	-	-
European badger	<i>Meles meles</i>	189.0	8.0	7.6	11.0	0.5	68.9
Red deer	<i>Cervus elaphus</i>	-	-	1,086.1	-	-	-
Wildcat	<i>Felis silvestris</i>	5.5	-	-	-	-	9.9
Roe deer	<i>Capreolus capreolus</i>	0.8	-	104.0	69.6	-	12.3
Red squirrel	<i>Sciurus vulgaris</i>	0.0	2.9	-	-	0.4	0.0
Beech marten	<i>Martes foina/martes</i>	36.6	107.3	4.3	6.2	21.9	41.3
Common genet	<i>Genetta genetta</i>	36.8	19.8	-	-	0.7	-
European hedgehog	<i>Erinaceus europaeus</i>	10.8	2.2	1.0	11.7	63.9	10.4
Stoat	<i>Mustela erminea</i>	1.1	2.6	-	-	-	1.7
European rabbit	<i>Oryctolagus cuniculus</i>	31.8	-	2.0	-	36.1	-
Rabbit/hare family	<i>Leporidae sp</i>	18.4	-	-	-	-	-
European hare	<i>Lepus europaeus</i>	12.3	-	47.2	124.7	0.5	36.3
Grey wolf	<i>Canis lupus</i>	-	-	1.0	-	-	-
European otter	<i>Lutra lutra</i>	2.0	0.9	-	-	-	-
Mammal class	<i>Mammalia sp</i>	1.8	-	-	-	-	-
Mustelid family	<i>Mustelidae sp</i>	1.7	3.7	2.3	-	-	5.2
European polecat	<i>Mustela putorius</i>	5.6	35.7	0.3	-	1.3	-
Coypu	<i>Myocastor coypus</i>	58.5	21.1	1.3	1.1	28.9	477.9
Muskrat	<i>Ondatra zibethicus</i>	2.6	2.4	-	-	-	-
Black rat	<i>Rattus rattus</i>	-	-	-	-	0.7	-
Brown rat	<i>Rattus norvegicus</i>	1.6	6.4	0.0	1.1	2.0	6.2
Raccoon	<i>Procyon lotor</i>	-	0.5	-	-	-	-
Rat genus	<i>Rattus sp</i>	3.8	4.3	-	-	1.1	0.0
Red fox	<i>Vulpes vulpes</i>	50.5	50.2	48.1	22.8	3.8	6.7

**BUILDING & MONITORING THE STRUCTURES**

Vernacular name	Scientific name	Average number of crossings detected per year per structure					
		Wildlife underpasses (n=35)	Modified hydraulic structures (n=14)	Wildlife overpasses (n=4)	Specific large fauna underpass (n=4)	Modified road structures (n=3)	Non-dedicated passageways (n=15)
Wild boar	<i>Sus scrofa</i>	5.5	-	149.5	3.9	0.2	3.0
European mole	<i>Talpa europaea</i>	0.4	-	-	-	-	-
<b>Nidifugous* walking birds</b>							
Mallard	<i>Anas platyrhynchos</i>	14.4	11.1	-	-	-	147.0
Common pheasant	<i>Phasianus colchicus</i>	0.0	-	0.3	3.2	-	-
Red-legged partridge	<i>Alectoris rufa</i>	1.3	-	-	-	3.4	-
Water rail	<i>Rallus aquaticus</i>	-	-	-	-	-	0.0
<b>SMALL MAMMALS, AMPHIBIANS &amp; REPTILES</b>		<b>8.5</b>	<b>0.8</b>	<b>1.5</b>	<b>34.3</b>	<b>24.5</b>	<b>0.0</b>
<b>Small mammals</b>							
Water vole family	<i>Arvicola sp</i>	2.4	-	-	-	-	-
Small mammals	<i>Micromammal sp</i>	3.4	0.4	0.3	34.3	12.4	0.0
Murid family	<i>Muridae sp</i>	7.8	0.5	0.3	-	8.1	0.0
Dormouse family	<i>Gliridae sp</i>	0.4	-	-	-	-	-
Soricidae family	<i>Soricidae sp</i>	3.5	-	-	-	-	-
<b>Amphibians/Reptiles</b>							
Frog family	<i>Anura sp</i>	0.8	-	-	-	1.4	0.0
Green whip snake	<i>Hierophis viridiflavus</i>	1.2	-	-	-	-	-
Common/spiny toad	<i>Bufo bufo/spinosus</i>	0.8	2.3	-	-	-	-
Agile frog	<i>Rana dalmatina</i>	0.4	-	-	-	-	-
Wall lizard	<i>Podarcis muralis</i>	0.0	0.0	-	-	-	-
Ocellated lizard	<i>Timon lepidus</i>	-	-	-	-	0.6	-
Lacertid family	<i>Lacertidae sp</i>	0.0	0.0	0.3	-	-	-
Fire salamander	<i>Salamandra salamandra</i>	5.3	-	-	-	-	-
Common wall gecko	<i>Tarentola mauritanica</i>	-	-	-	-	1.1	-
Newt family	<i>Triturus sp</i>	1.6	-	-	-	-	-

### **Noteworthy observations from photographic monitoring**

The following points give a general account of the main highlights from the monitoring using camera traps. All of the results and analyses are provided in the complete feedback report.

#### **Wildlife tunnels**

##### **A wide variety of animal species use the tunnels.**

The 35 wildlife tunnels that were monitored (with diameters ranging from 0.8 to 1.2 metres, and lengths between 31 and 75m) are used very frequently (an average of 300 crossings per year per structure including for all species) by a remarkable variety of species (25 mammal species, 5 amphibian/reptile species, and 3 nidifugous\* bird species).



Photo n°12: **European badgers in a wildlife tunnel measuring 120cm.** (© LPO France, VINCI Autoroutes)

##### **The wildlife tunnels can be used by wild boar and deer.**

The number of wild boar and deer observed inside the wildlife tunnels reveals their occasional yet consistent use of these structures that were not designed for these species in terms of size (on one occasion, wild boar surprisingly crossed a culvert with a diameter of 80 cm).



Photo n°13: **Roe deer in a wildlife tunnel measuring 120 cm.** (© LPO France, VINCI Autoroutes)

##### **Certain species are difficult to detect.**

Despite the structure's confined space, there is a lower detection bias. Certain species are difficult to detect with the infrared sensor: the European otter due to its insulated fur (21 crossing readings in 5 different structures), small mammals and species that are small in size (Weasel) due to their rapid movements.



Photo n°14: **Otter "Marguerite" in a wildlife tunnel measuring 120 cm.** (© LPO France, VINCI Autoroutes)

### Modified hydraulic structures

#### **Hydraulic structures used less frequently than wildlife tunnels.**

With 20 detected species, the 15 modified hydraulic structures (riprap, culvert walkway and corbel constructions) showed less diversity, and were used two times less than wildlife underpasses. Significant differences in use were observed for certain species in particular: the beech marten, European pine marten and polecat of the Mustelidæ family were present in the modified hydraulic structures, whereas the genet, coypu, hedgehog and badger are more frequently detected in wildlife tunnels.

#### **Monitoring more complicated in hydraulic structures.**

Monitoring is more complicated in these structures as the diameter is often larger (detection coverage), attaching the monitoring devices is more difficult, and fauna may cross on the exposed bed during summer months.



Photo n°15: **Common genet on a corbel.**  
(© Nature Midi Pyrénées, VINCI Autoroutes)



Photo n°16: **European pine marten on the riprap lining of a hydraulic structure.**  
(©FRAPNA42, FDC42, VINCI Autoroutes)

### Wildlife overpasses

#### **Significant use by the red deer.**

The 4 wildlife overpasses that were monitored enabled the detection of 16 species. At a wildlife overpass located in an area frequented by red deer, this species was observed using the structure daily, with an average of 1,086 crossings per year, and balanced exchanges between both sides of the overpass.



Photo n°17: **Red deer on a wildlife overpass.**  
(©FDC17, VINCI Autoroutes)

#### **Poor detection of small animals.**

While large animals are fairly well detected on wildlife overpasses, monitoring small animals is much more complicated, and becomes even more challenging with the growth of vegetation. The monitoring of these structures therefore requires camera traps to be placed in strategic locations (along windrows, palisades/fences) that are used as movement corridors for small animals.

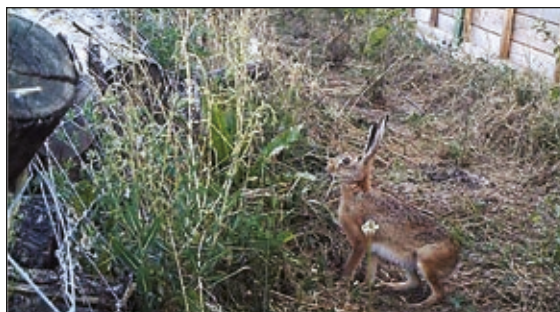

Photo n°18: **European hare alongside a windrow on a wildlife overpass.** (© LPO France, VINCI Autoroutes)



## **SPECIFIC MONITORING**

For large structures (wildlife overpasses) and specialized structures (bat bridges, aquatic passages, etc.), specific monitoring was set up for certain taxons\* (amphibians, bats, etc.). This specific monitoring required materials and protocol that were very different and, as such, were difficult to compare with other data, yet this monitoring provided a better understanding of the detection bias of certain monitoring methods such as the use of camera traps.

It enabled the detection of 46 species, including 14 mammal species, 11 bat species, 7 amphibian species, 6 small mammal species, 5 reptile species, and 3 fish species.

### **Noteworthy observations from the specific monitoring**

The noteworthy findings from the specific monitoring are summarized below. The detailed results of all of the monitoring can be found in the full feedback report.

#### **Time-lapse monitoring**

##### **The nature of the substrate in wildlife tunnels undoubtedly determines the structure's use by amphibians.**

Time-lapse monitoring (camera trap automatically triggered once a minute) provided 34 data items on amphibians (22 crossings) of 4 different species that were not detected by infrared sensors. This monitoring reveals the species' capacity to cross structures spanning over 50m, and led to a hypothesis on the species' ease of movement across a smooth substrate (without microrelief).



Photo n°19: **Fire salamander in a wildlife tunnel with a width of 55cm and a length of 50m.**  
(@ LPO Drôme, VINCI Autoroutes)

#### **Small mammal capture sessions**

##### **Wildlife overpasses, crossing points and living spaces.**

Small mammal capture sessions, conducted on and beside a wildlife overpass, provided a better understanding of how the overpass space is used by various species. The mosaic of environments present on the structure creates a habitat continuum for certain species, enabling the connection of populations from both sides of the overpass.

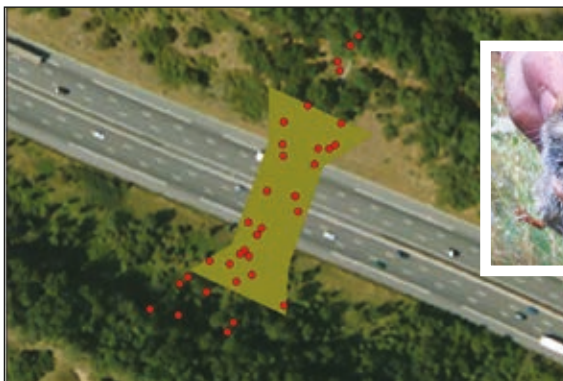

Photo n°20: **Mapping (in red) of greater white-toothed shrew captures on and beside the wildlife overpass.** (@ LPO Drôme, VINCI Autoroutes)



Photo n°21: **INRA trap and small mammal capture on a wildlife overpass.**  
(@ LPO Drôme, VINCI Autoroutes)

---

### **Vibration sensor**

#### **An innovative device that improves detection.**

In an effort to offset the detection bias observed for the European otter in particular (whose insulating fur prevents it from being easily detected by an infrared sensor), ASF, the LPO and JAMA worked together to develop a vibration sensor “trap” (with a pressure sensor).

Today this equipment is not only able to detect mammals (especially small mustelids, among others) and small mammals more reliably than an infrared camera trap, it is also able to detect amphibians and reptiles, which were almost impossible to detect using infrared sensors.

This device provides a detection increase (for all types of taxons\*) of 35%, as compared to an infrared camera trap. It is limited by the size of the vibration mat, but is an ideal option for monitoring a structure with a width of 1m for example, and shows great potential for monitoring herpetofauna and small mammals.

This innovative device won a VINCI Innovation award in 2015 (Central Activities, Sustainable Development category).



Photo n°22: **European otter on a vibration sensor.**  
(© LPO France, VINCI Autoroutes)

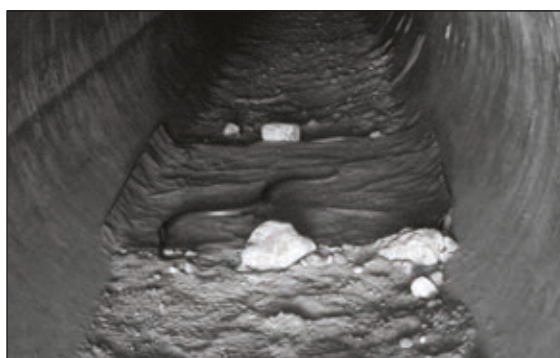

Photo n°23: **Green whip snake on a vibration trap.**  
(© LPO France, VINCI Autoroutes)

---

### **Thermal imaging camera**

#### **Visualizing bat flight trajectories.**

The thermal imaging camera enables direct visualization of bats' flight paths near the dedicated structures. This feature is not possible using ultrasonic methods (with a single recorder) in an open environment. A monitoring period of 26 accumulated hours carried out near 2 bat bridges provided views of 28 bat crossings, as well as the initial monitoring elements for this type of structure, still in its experimental stage.



Photo n°24: **Thermal imaging camera facing a bat bridge.**  
(© Naturalia, VINCI Autoroutes)

## FINDINGS FROM THE DATA ANALYSIS (CAMERA TRAPS)

### Observing wildlife becoming accustomed to the structures

In general, the analysis of data, or of specific homogeneous data sets, reveals an increase in the fauna's use of the structure over the course of the monitoring period.

The following chart shows the correlation between the number of wildlife crossings and the number of days of monitoring the 46 different structures.

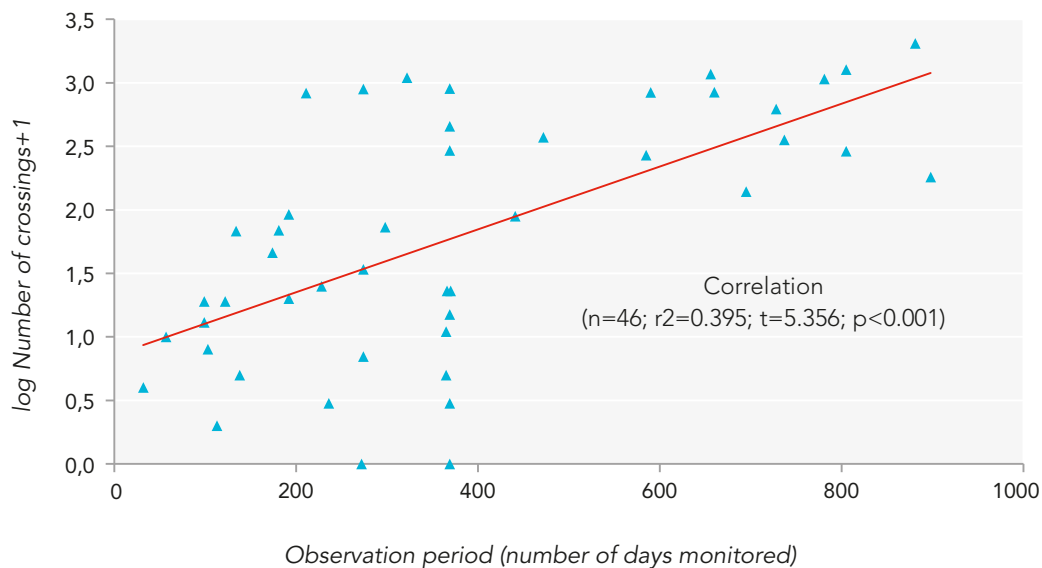

Figure n°1: **Logarithm of the number of species crossing versus the monitoring effort in terms of the number of days in the monitoring period, for 46 structures (wildlife overpasses and modified hydraulic structures). A triangle stands for the monitoring of a structure, the line reveals the linear trend of the data.**

As seen in *Figure n°1* above, detailed statistical analysis (see complete report) based on a limited set of data (9 wildlife overpasses) also reveals the phenomenon of animals growing accustomed to the structures, with the result that they use the structures eight times more frequently over the course of two years of monitoring.

This accustomization of wildlife to the structures over time can be explained by the amount of time it takes for the fauna to find the structures and integrate them into their movement patterns. The time before the first crossing of the structure varies significantly according to the species. Some species, like the European hedgehog, European otter and wild boar take on average almost one year or more to cross a new structure, unlike the fox, for example, which will use the structure after 3 months on average. This shows the importance of planning for several years of monitoring on new road structures.

### Links between a structure's length and its use by fauna

The length of a structure (a factor that is generally correlated with the diameter) is often identified as a factor that could limit the fauna's use of the structure. The analyses conducted as part of the study by Fagart et al. (2016) over a 2-year period of monitoring of 9 wildlife overpasses with lengths varying from 41m to 71m, revealed that the length did not significantly influence use of the structures, regardless of the species (for the species that were most represented: *martes sp*, Badger, Fox, Genet).

In the feedback report, for wildlife overpasses varying from 31m to 75m in length, and modified hydraulic structures varying in length between 48m and 100m, the statistical analyses do not reveal significant differences in the use of the structures.

Structures exceeding 80m are used less frequently by fauna. In order to see the potential impacts of a structure's length, greater focus must be given to the 6 structures with a length exceeding 80m (5 modified hydraulic structures and 4 structures not intended for fauna), for which the average frequency of use is rather low, with 49.8 crossings/year/structure, and not very diverse, with only 6 species. Excluding *martes sp.*, which accounts for nearly 3/4 of all crossings of all fauna types on these structures, and the surprising presence of the red squirrel, the other species that were detected are burrowing species used to digging holes (Fox, Coypu, Badger, and Stoat) and therefore predisposed to using structures with a significant tunnel effect. The genet, lagomorphs, hedgehog, as well as the largest fauna (roe deer, wild boar), for example, were not detected in these structures. The two longest structures, hydraulic structures measuring 105m and 140m in length, are used exclusively by the *martes*.

*Note: While it is probable that a structure's length could hinder or even prevent its use by certain species/individuals, monitoring also shows that these structures remain functional for mammals, and can therefore be very significant for individuals seeking partners or new territories.*

### Wildlife underpasses near an ecological corridor used more frequently

When no specific species are targeted, a fauna passage is intended to enable crossing by a maximum amount of wildlife species and individuals. In most cases, wooded streams, forest edges, or hedges guide the movements of a considerable number of species. A comparison of crossing data between the wildlife underpasses located along a watercourse and those not associated with a watercourse reveals that the former are used by a greater number of species (28 species as opposed to 20), with a much higher average use (on average 401 crossings/year/structure, compared to 226 crossings/year/structure for wildlife tunnels not associated with a watercourse).

While the location of motorway fauna passages is usually optimized, taking the many different technical constraints into account (for example the height of the embankment), the locations could be improved/optimized by connecting the entrances to the wildlife structures with existing natural corridors (artificial paths, adding hedgerows, etc.).



Photo n°25: **Blackout panels on a wildlife overpass.** (© VINCI Autoroutes)



Photo n°26: Camera trap secured on a wildlife overpass, positioned at the same level as a windrow. (© VINCI Autoroutes)

# **SUMMARY** **OF MONITORING** **PROTOCOLS** **BASED ON** **THE GROUPS** **OF SPECIES**

## Technical data sheet 1

# GENERAL MONITORING OF MAMMALS USING CAMERA TRAPS

Over the past several years, the camera trap has become the tool used most frequently for monitoring land mammals. Yet this type of device does not provide exhaustive results and represents quite a few biases. Although the installation and use of the equipment seems simple, some experience is required in order to optimize the monitoring and reduce detection biases of the devices equipped with infrared sensors.



### CAMERA TRAP DETECTION BIASES

- Do not detect cold-blooded animals (and potentially the fur of semi-aquatic mustelids\*).
- Poor detection of low temperature gradients (semi-aquatic mustelids, high background temperature).
- Poor detection of small animals and/or animals that move quickly (small mammals, weasels, etc.).

### INSTALLATION OF A CAMERA TRAP IN AN UNDERPASS

Installing the **camera trap inside the structure** (rather than outside) shelters it from the external elements (rain, wind, variations in temperature, plants, etc.) and provides a better view of the crossings.

Inside, the device is placed **approximately 5m from one end of the structure**. A device placed in the middle of the structure is sometimes less effective (up to 40% less detection), which can be explained by the speed of the animal being potentially greater in the middle of the structure than at the ends.



**The camera viewing angle is turned towards the inside of the structure** (longest side) in order to better view the crossings, and have a fairly consistent reference temperature in the background.

**A stone or natural debris can be placed in front of the camera trap** (where detection will be most effective). This surface relief, marked and sniffed by the animals, serves to slow their pace and increase the chances of detection/identification.

### INSTALLATION OF A CAMERA TRAP ON AN OVERPASS

The entire area to be monitored must be covered by the detection beam(s); therefore the number of camera traps must be increased accordingly and must cover the area evenly. For example, in a wildlife overpass with a width of 15m, 2 camera traps located on each side will evenly cover the width. The presence of embankments/relief may also require the installation of additional camera traps.

In the open, plant growth can make the detection of small fauna (animals smaller than a badger) very difficult and uncertain. The structural landscape components in the immediate vicinity (windrows, palisades, fences, hedgerows, etc.) are often used as corridors for small fauna, and should be targeted in order to monitor these species.

Avoid angles directly facing the sun's path (sunrise/sunset) or water surfaces that could reflect the sunlight (continuous activation of the camera could drain the battery within a few hours).



### POSITIONING OF THE CAMERA TRAP

The direction and angle of the camera must be adapted to the characteristics of the infrared movement detector (see the operating instructions for the equipment), the layout of the landscape (relief, anchor points), and the targeted species.

Camera trap too close to the movement corridor  
= Animal is quickly outside of the viewing angle

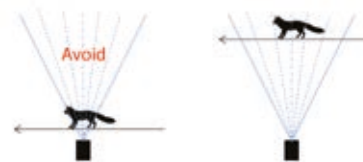

Camera trap within the axis of the movement  
= Possible detection bias  
(for detection by strips - see report in French)



### DEVICE AUTONOMY

Minimum 1 month; this allows for long-term monitoring, but also results in a substantial amount of time spent recording the data.

Warning: the choice and quality of conventional or rechargeable batteries considerably influences the autonomy of the device (good cost/effectiveness compromise for NiMH) batteries.

### DURATION/MONITORING PERIOD

An entire year is required in order to avoid the seasonal phenology factor.

The process of the wildlife becoming accustomed to the structure and/or monitoring device generally requires monitoring to last several years. A 3-year period would be appropriate.



## Technical data sheet 2

# MONITORING SMALL MAMMALS



### DETECTION BIASES

Small individuals: poor detection, blurry resolution, hidden movements.

Fast individuals: poor detection, difficulty in interpreting the movements/data.

### THE CASE OF UNDERGROUND STRUCTURES

Small mammals have small home ranges; therefore they are hesitant and do not often cross underground road structures that generally measure over 30m in length. The absence of vegetation and “refuge zones” makes them vulnerable and they are therefore unwilling to cross these distances exposed.

In small structures, vibration traps and camera traps (positioned near the floor) enable the collection of a significant amount of data. However, this data is difficult to interpret (unclear identification, crossing or not, detection bias, etc.).



### THE CASE OF LARGE STRUCTURES (WILDLIFE OVERPASSES AND LARGE FAUNA UNDERPASSES)

In exposed (wildlife overpasses) and semi-exposed structures (large fauna underpasses), where there are plants or refuge zones (windrows), micro-habitats enable small populations to form a habitat continuum within the structures themselves.

For these structures, the trapping method (capture-mark-recapture, non-lethal) is the most appropriate form of monitoring:

- traps are spread out over the entire wildlife passage (ex: approximately 50 traps for one wildlife overpass);
- traps placed near the edges of the structures;
- each trap is numbered and geolocated in order to make optimal use of the data;
- the traps are regularly checked at night to prevent mortality;
- marking can be used in order to identify the individuals in the event of a potential recapture.



### DURATION/MONITORING PERIOD

**Camera trap/vibration sensor:** minimum period of one year (phenology, plant growth).

**Capture:** short trapping sessions (1 night), repeated over a one-year period (e.g. 2 nights in spring + 2 in summer + 2 in autumn).



## Technical data sheet 3

# MONITORING HERPETOFAUNA (AMPHIBIANS AND REPTILES)



## DETECTION BIASES

It is nearly impossible to detect ectothermic\* animals using an infrared sensor.

The vibration sensor is a new alternative for the automated monitoring of these species.

## THE CASE OF UNDERGROUND STRUCTURES

### Vibration sensor:

- very high detectability for Anurans\*, and probably fairly high for Urodelans\* and reptiles;
- ideal for structures with a maximum floor width of 1m (detection mat limited to a width of 1m, although this may change in the future).



### Time-lapse camera trap (activated every minute):

- good detectability of Anurans and Urodelans (slow movements);
- not suitable for reptiles (move too quickly);
- reduces the autonomy of the equipment by approximately 2 weeks;
- produces a large number of images to review.



## THE CASE OF LARGE STRUCTURES (WILDLIFE OVERPASSES AND LARGE FAUNA UNDERPASSES)

The most effective method for monitoring herpetofauna remains direct observation and searching for signs of the species' presence on the structure during targeted surveys.

The use of a collection system for amphibians (tarpaulin) is very intrusive, and requires that someone be constantly present in order to monitor the system.

The use of time-lapse camera traps in the targeted areas (wetland depression for amphibians, thermoregulatory plate for reptiles), have yet to be tested.

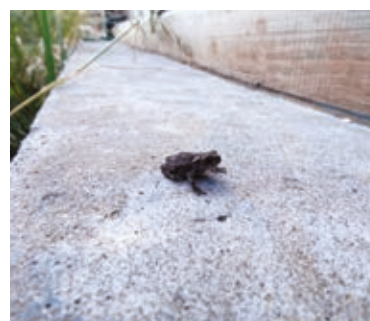

## DURATION/MONITORING PERIOD

**Amphibians:** main peak in amphibian use of the structures occurs during their autumnal migration (October-November). Significant activity also takes place during the reproduction period (March-June).

**Reptiles:** hot days from spring to autumn.

## Technical data sheet 4

# MONITORING BATS



### DETECTION BIASES

**Ultrasonic recorder:** a detection distance of a few metres (Rhinolophus) to several tens of metres (Noctule); monitoring is not uniform for large structures.

**Thermal imaging or infrared camera/detection:** visual identification is very unreliable, should be combined with an ultrasonic sensor .

### THE CASE OF UNDERGROUND STRUCTURES

Ultrasonic recording (SongMeter, Anabat) is the most effective monitoring method for structures over 30m long.

The recorder must be placed in the middle of the structure in order to isolate the recorded sounds from those coming from outside the structure.

Another recorder can be placed outside the structure, for example on the same level as the motorway, in order to provide a reference on bat activity in the vicinity.



### THE CASE OF LARGE STRUCTURES (WILDLIFE OVERPASSES AND LARGE FAUNA UNDERPASSES)

It is still difficult to study bats crossing linear transport structures; it is a complicated task requiring the use of recent techniques.

Flight paths can today be perceived through mapping provided via flight path tracking techniques (several microphones operating simultaneously to map out the 3D trajectories). Flight paths can also be accurately filmed using a high-performance thermal imaging camera.

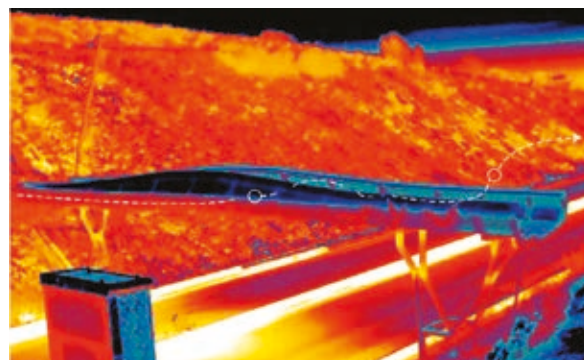

### DURATION/MONITORING PERIOD

**Ultrasonic recorder:** significant autonomy (several weeks), yet due to the very time-consuming nature of the recording analysis, it is advisable to concentrate recording sessions during periods that are favourable for bat movement. For example, 3 sessions lasting 2 - 5 days; taking place in the spring (post-hibernation), summer (reproduction) and autumn (rut).

**Thermal imaging camera + sensor:** the equipment is not autonomous, it requires an observer. Observations can be repeated according to the monitoring objectives.



Photo n°27: Wildlife overpass in the Rhône Valley. (© Alterra, VINCI Autoroutes).

# ANNEXES

## Methodology sheet 1

# WILDLIFE UNDERPASS

Specifications from the feedback report on the design/construction of wildlife underpasses.

### HEADWALL CONSTRUCTION PROCESS

The headwalls are generally made of cast concrete (preferred in order to respect the slopes of the embankments), in order to:

- “enter” into the embankment (excavation) and help achieve the funnel effect;
- maintain the land;
- perfectly connect the headwalls with the surrounding fences, using mortar joint sealant;
- significantly reduce maintenance in the future, due to the concrete apron covered with soil that prevents the growth of ligneous plants.

The assembly of the pipe culverts must contain an elastomer seal.

The boring must be set above the Q100 flood level (wildlife underpass, not for hydraulic structure).

The approach ramp’s degree of opening is approximately 30° with the pipe culvert as the axis of reference (see *Figure n°2*).

In the event that the headwalls are set into the embankment slope, the concrete apron must be extended with a slightly sloping masonry ramp with stone seals creating a rough surface (overhang of 4-5 cm) to support the layer of soil that will be applied (approximately 15 cm of soil).

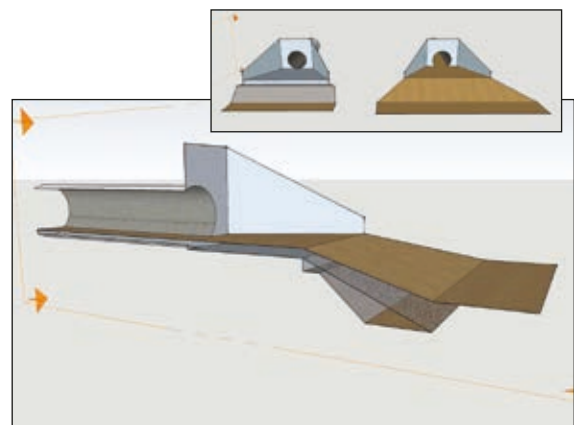

Figure n°2: Operational diagram of a ramp.



Photo n°28: Construction of a masonry ramp before it is covered with soil. (© VINCI Autoroutes).

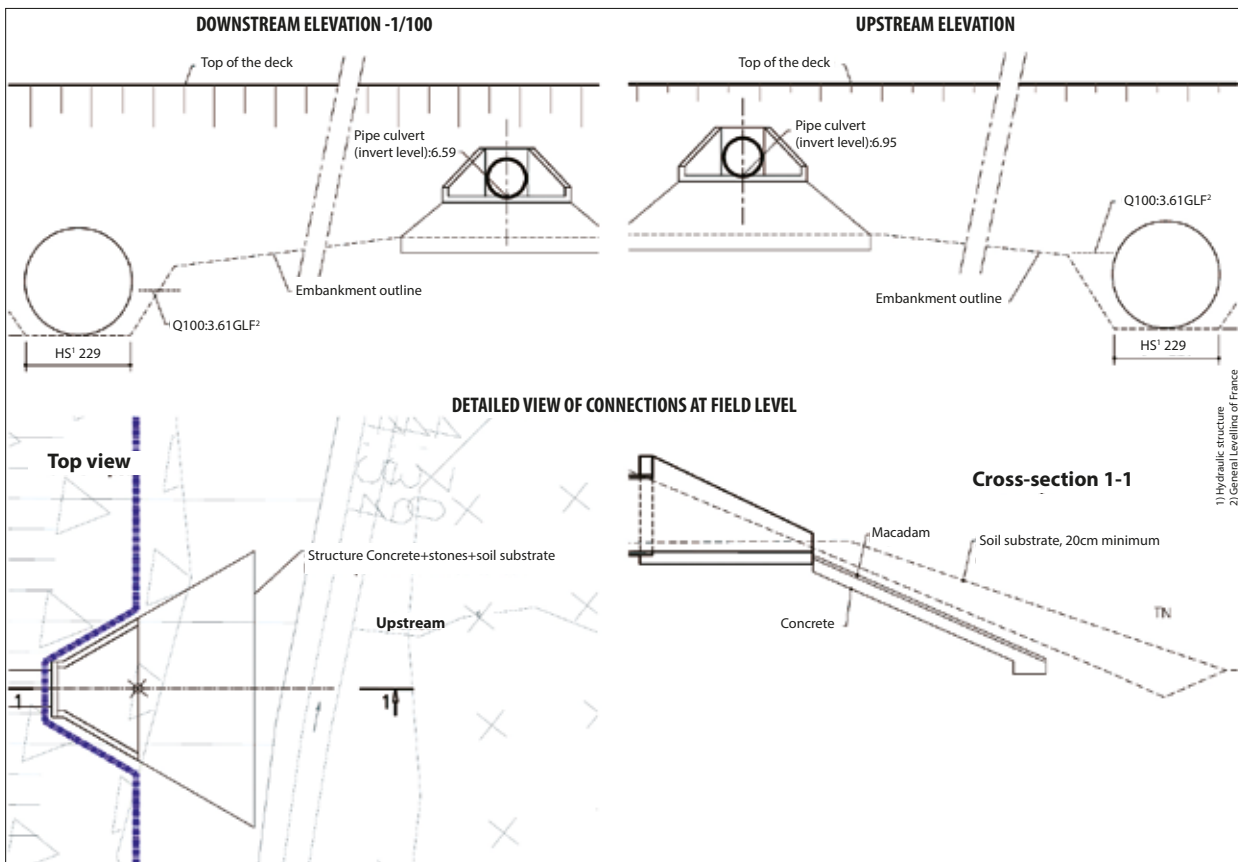

Figure n°3: Plan of a wildlife underpass from the draft-design studies, which shows the Q100 and elevations.

## TECHNIQUES, ALLOWABLE TOLERANCES AND HOLD POINTS

The pipe culverts are often installed by boring into the ground with the back of an excavating machine (hydraulic auger). The installation of pipe culverts sometimes requires the use of a microtunnel boring machine, if the traffic and other conditions permit. A frequently used alternative is the "open-ended\*" installation technique, when the distribution of block sizes limits the use of augers.

Sufficient geotechnical field investigations (surveys of the hard shoulder + compact excavator on embankments) will provide information on this risk.

The pipe culverts are made of metal, concrete or GRP\*.

The following are the maximum deviations **for the most common use of the auger**:

- planimetrics: plus or minus 1cm based on the initially planned dip).

The positioning of the altimetric alignments will be constantly inspected.

For the metallic pipe culverts that are bored (carried out according to Paper 66 of the CCTG), the pipes will be made of steel and their thickness will be specified and justified by a calculation report to ensure they feature the required mechanical resistance to withstand the pressure caused by the boring operation. The thickness of the pipes must allow for the thickness lost to corrosion, taking into account the corrosiveness of the soil types at the site, in accordance with the recommendations in the EN 1993-5 standard, based on a period of use of 100 years, and calculating a minimum of 2mm for the sacrificial thickness.

Plan for a containment system for the front, or a filling in order to constantly ensure the stability of the front.

The topographical monitoring (plan and altimetry) of the road-bed will be established at the time of construction. This monitoring will take place from outside the road-bed, to avoid any interference with traffic.

It is often necessary to plan for a clearing phase to remove underbrush, in order to gain a clear understanding of the site's layout and detect the potential presence of cunettes or ditches that were not previously detected and that could have a significant impact on the construction methods and the installation of the fencing.



Photos n°29: Auger techniques: in the foreground, blocks that exceed the diameter limit (left) on A11, open-ended technique (above right) and a solid block excavated using this technique (bottom right (A83)). (© VINCI Autoroutes).

## SOIL ADDITION

Plan for soil addition for inside the underpass and on the approach ramps with a thickness of 10 - 15cm (minimum of 10cm). Topsoil type without too much clay (expands) or limestone (hardens) (if possible, aim for the following composition: sand 40-50%, silt 30-40%, clay 10-20%).

## FENCES

Reinforcement of small-mesh wire fencing over approximately 150ml on both sides of the underpass, for a total of approximately 600ml covered.

The lining covering the motorway fencing is made up of 2 layers of small-mesh fencing made of coated galvanized steel:

- lining with apertures of 6.5 x 6.5mm (wire Ø: 0.7 mm);
- lining with apertures of 25 x 13mm or 25 x 25mm (wire Ø: 1.8mm) semi-buried 30cm in the ground and a minimum of 70cm above ground (see Figure n°4, page 37; Photos n°30, page 37; Photo n°31, page 38).

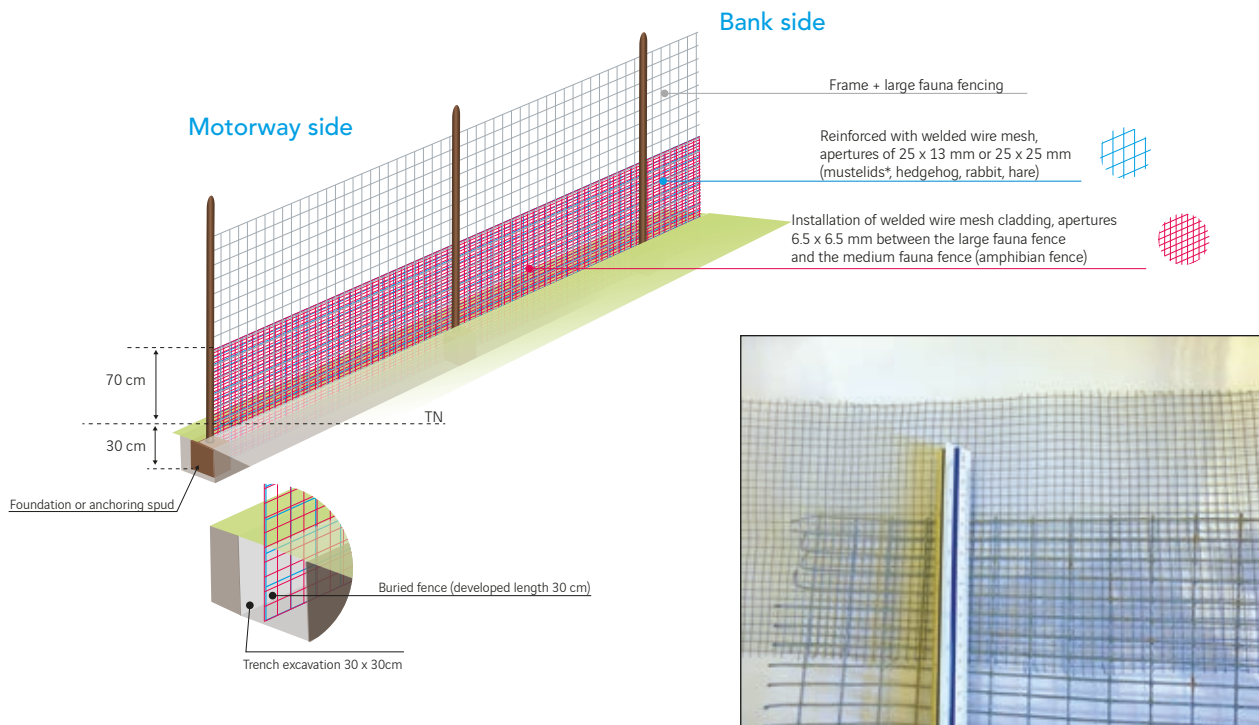

Figure n°4: Mesh with apertures of 6.5 x 6.5mm and of 25 x 13mm (left), diagram of the lining principle (right).

*[Note: the 6.5 x 6.5mm lining is only type able to guide amphibians, but its lifecycle is very limited due to its fragile nature. The additional layer of the more robust 25 x 13mm or 25 x 25mm fencing with a wire Ø of 1.8 significantly increases its duration].*



Photos n°30: Lined fencing being repositioned and semi-buried (photo, left), mortar joint sealing on the fencing around the headwall (photo, right). (© VINCI Autoroutes).

Creating crossings for ditches/cunettes (and using American-style wire gates) is a delicate matter, as it can create weak spots that could allow small animals to pass through the fencing, thus compromising the intended purpose of guiding the fauna. This problem can often be avoided by repositioning the fences.

One possible solution is to construct a mini masonry threshold at a higher level (if the slope allows for this) with the fencing crossing in front of the threshold. Other options including installing a reinforced fence or a PVC tube with a large diameter that features a check valve.



Photo n°31: A check valve set-up, only adapted to certain cases (fence crossing a ditch). (© VINCI Autoroutes).

## EQUIPMENT FOR ECOLOGICAL MONITORING

Plan to have a specialist firm firmly secure an L-shaped mounting angle bar to the walls (to avoid damage and theft) inside the wildlife underpass.

### SPECIFIC CONDITIONS FOR PHOTOGRAPHICALLY MONITORING WILDLIFE UNDERPASSES

Monitoring this type of structure requires the installation of a camera trap in a location that is accessible for regular data collection and, if possible, is protected from the elements and out of sight of pedestrians. An installation on the ground obstructs an often narrow passage (wildlife tunnels with a diameter between 800 and 1,200mm). Installing a mounting angle on the upper part of the structure (maintaining a 15cm air draught above) 5m inside the tunnel enables the installation of a camera trap facing the longest side (to better observe fauna crossing and turning back), and allows the trap to be somewhat hidden.

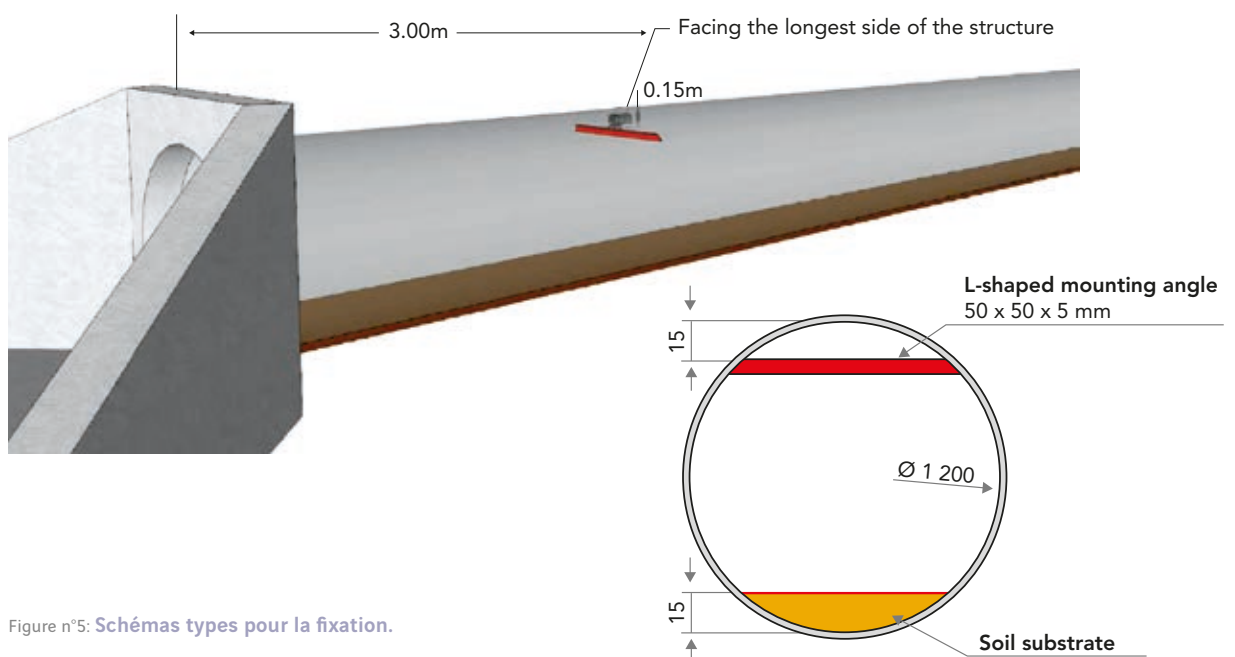

Figure n°5: Schémas types pour la fixation.



## THE WORKSITE

Road and land allowances must be in compliance with the environmental specifications adopted at the time of the initial ecological state study (respecting integration measures, markings, protected areas, etc.), which should be determined during the draft-design stage.

The roads, storage area, and planned worksite deck must be installed on top of geotextile with filler materials. The geotextile will facilitate the subsequent removal and the process of returning the site to its natural state.

The work deck will be fenced off (e.g. Héras type fencing). The geotextile must be attached to the fencing, at a height of approximately 1m, for the following reasons:

- to prevent materials from leaking into the natural environment;
- to avoid intrusions (risks of damage, CNPN-French Council for Nature Protection) caused by small animals entering the work zone.

Because wetlands and streams are often in close proximity to the worksite, adequate filtration devices should be installed on the worksite.

Ensure that the stream banks are stable if they are very near the worksite (vibrations could potentially cause a landslide or the leakage of suspended solids). It may be necessary to take preventive stabilisation measures (geo mesh and wooden stakes).



Photos n°33: **Correct storage on geotextile with pipe culvert on wooden wedges.** (© VINCI Autoroutes).



Photos n°34: **Storage of the prefabricated parts of a culvert walkway.** (© VINCI Autoroutes).



Photos n°32: **Work deck at the Marguerite (A10) Wildlife Underpass worksite with a generator on top of a covered surface and geotextile in compliance with the recommendations (photo, left). Note the close proximity of the stream and the preservation of certain trees on the site (photo, right).** (© VINCI Autoroutes).

## Methodology sheet 2

# WILDLIFE OVERPASS

Specifications from the feedback report on the design/construction of wildlife overpasses.

### DECKS AND APPROACH RAMP

Aim for the greatest possible width (often between 15 and 25m), while seeking to reduce the  $\frac{\text{length}}{\text{width}}$  ratio. In general, these structures are standard-sized (under 1,200m<sup>2</sup>, not requiring the preliminary studies for engineering structures — see non-standard structures cf. in the Circular n°87-88 of 27/10/1987).

Simple technical solutions should be encouraged (no architectural designs) *(for ecological purposes, what matters most is the not the overpass itself, but what is on top of it)*.

A “diabolo” aspect is preferable, with trapezoidal inlets (rectangular deck), and approach ramps widened as much as possible.

It is possible, and often advisable, to design asymmetrical approach ramps (° of opening) to adapt to the specific layout (e.g. sewage system on one end).

### BLACKOUT PANELS

Blackout panels are installed on the deck and on both approach ramps, ending at the connection with the natural ground of the embankment. It is preferable to install the panels in straight lines on the approach ramps, thus avoiding curves that can be difficult to carry out.

Close attention should be paid to the joints between the panels and their bases, in order to prevent any light from shining through (see Figure n°6, page 41).



Photo n°35: **Wildlife overpass.** (© VINCI Autoroutes).

### SOIL

The thickness of the soil on the deck is generally 20-30cm on the main section (to sow herbaceous plants) and 80-90cm thick on the sides (to plant wooded strips on the banks) forming strips with a width of 5m (see Figure n°6, page 41). This layout is also beneficial for the monitoring process, since it contains the growth of herbaceous plants, due to the summertime stresses, which can potentially interfere with the camera traps' detection systems. Adding sand or gravelly sands (0-6 mm) in strips or mixed with soil can complement these measures to keep the central areas open.

Thicker soil must be planned on the approach ramps (minimum 1m, which could require the installation of geotextile on compacted backfill, depending on the situation).

Soil type: topsoil.

Considering the volumes of soil needed for the deck and approach ramps, particular attention must be paid to the risk of invasive plant species spreading, such as ragweed, which represents a regulatory issue (see prefectural ordinances by French department). Model specifications and tests in the planting market should be anticipated.

**SPECIFIC THEORY FOR THE DIMENSIONS**

**Dead weight excluding soil**

The dead weight of the structure and superstructure will be measured by applying the Eurocode EN 1991-1-1.

The maximum and minimum characteristic values will be measured by applying the Circular Directives Communes 79.

**Soil load**

- Mass density: 20.0 kN/m<sup>3</sup>
- Lateral strips (value for one strip on one side):

Dimensions (m)	Nominal value	Variation
Width	5.00	-0 / +1.00
Thickness	0.80	-0.20 / +0.30

Talus à 1/1

- Central section:

Dimensions (m)	Nominal value	Variation
Width	W	-2.00 / +0
Thickness	0.20	-0.00 / +0.20

W = width of the structure between the panels, minus the strips (W=15m in Figure n°6).

**Windrows**

Mass density: 20.0 kN/m<sup>3</sup>.

A windrow will be illustrated as a parallelepiped with a block measuring 0.80x0.80 m, spanning the length of the structure, with its axis at W/4 that of the structure's axis.

**Impermeability**

The impermeability will comply with Paper 67 Title III and must have received technical approval from the CETU (Tunnel Engineering Centre).

For overpass structures, a choice of thick, complex materials will be glued to the base. The 1<sup>st</sup> layer will cover the recesses all along the lateral panel support beams.

**Operational loads**

**Road overload control:** An LM1 type design load will be used (see Eurocode EN 1991-2) applied to a single lane (of 3 m in length) on any area between the 2 panels (budget calculation).

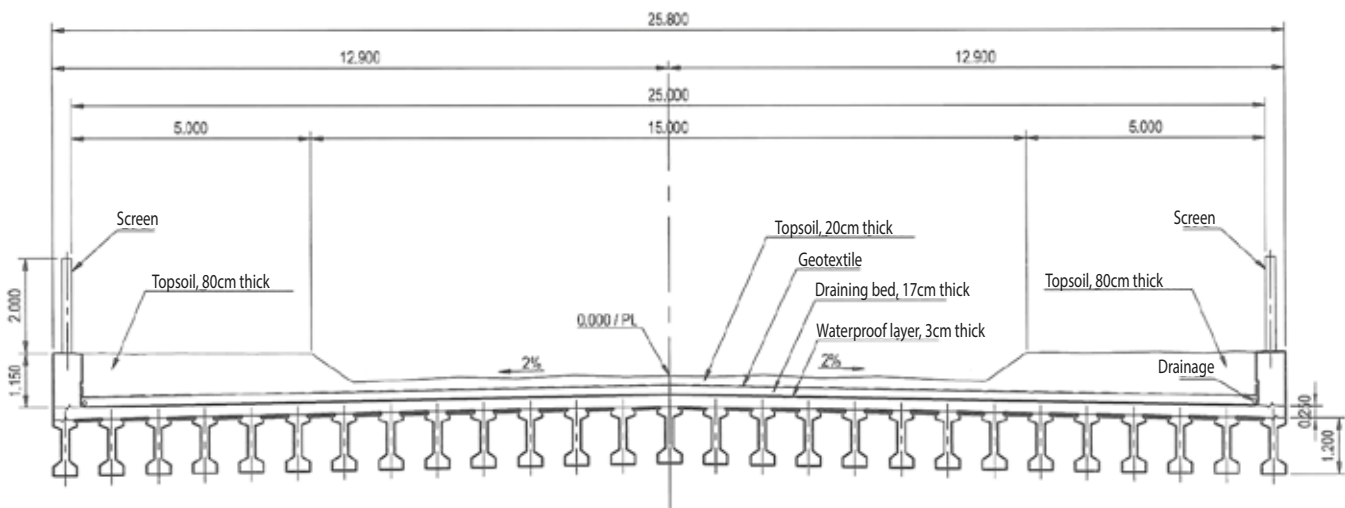

Figure n°6: Coupe avec répartition des épaisseurs de terre.

This load will enable the structure to support emergency vehicles driving at low speed (hence without creating a horizontal strain or dynamic effects). This should only be considered as an ELS\* model, accumulated with the maximum soil load, with the coefficients of the first traffic class.

**Worksite overload control:** to be defined on a case-by-case basis if the motorway overload limits above do not sufficiently cover the worksite phases (particularly the backfilling work).

**Overload control for the approach ramp backfill,** for the study of the walls and abutments: 1t/m<sup>2</sup>.

### Climate loads

In compliance with the Eurocode EN 1191-1-3, a snow load will be applied to the structure, and assessed based on its geographical location. The blackout panels should be considered obstacles in the meaning of Article 6.2 of the Eurocode (accumulation). The snow will not be accumulated with the road overloads.

### CHOICES AND OPTIONS SELECTED FOR COMPLIANCE WITH THE EUROCODES

- Consequence class: CC2.
- Reliability class: RC2.
- Project supervision level: DSL3.
- Inspection level during execution: IL3.
- Lifetime: 100 years.

### SCREENS AND FENCING

Unlike wildlife underpasses and other hydraulic structures, for the overpass, it is necessary to install screens in order to maintain the shady areas along the structure's edges.

The installation of polyethylene screens (75% opaque) on the repositioned fences and on a length of approximately 25 lm as an extension of the blackout panels on both sides in both directions, for a total of about 10 metres. Plan to add additional fence posts and struts to ensure that the screens will be wind resistant (see Photos n°36).

Small-mesh wire fencing will be added to reinforce both sides of the overpass in both directions.

The lining to reinforce the motorway fencing can be made of two layers of small-mesh fencing made with coated galvanized steel:

- lining with apertures of 6.5 x 6.5mm (wire Ø: 0.7 mm);
- lining with apertures of 25 x 13mm or 25 x 25mm (wire Ø: 1.8mm) semi-buried 30cm in the ground and a minimum of 70cm above ground (see Figure n°7, page 43).

Plan for connections between the fencing and screens that prevent small animals from crossing through (see Figure n°7, page 43).

It is necessary to reposition and replace the fencing at variable lengths in order to create a funnel effect.



Photos n°36: Acceptable connection, screen with supporting struts, and a flexible joint under a screen (left to right).

(© VINCI Autoroutes)

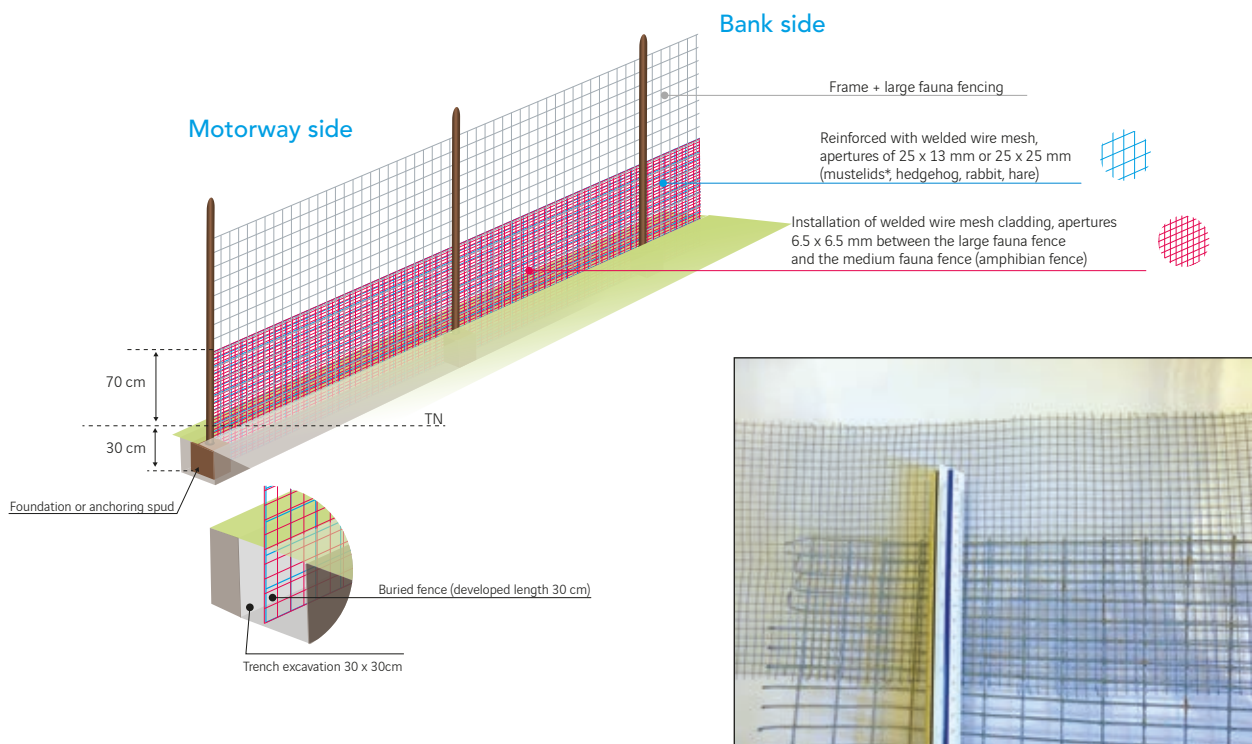

Figure n°7: Reinforcement lining with 6.5 x 6.5 mm + 25 x 13 mm apertures and reinforcement diagram.

## ENVIRONMENTAL ENGINEERING

### Plantings

Three types of vegetation should be planned for:

- trees and shrubs on the wooded strips of the deck and on the approach ramps (in lines);
- isolated planting of shrubs on the deck;
- herbaceous plants sown on the deck and approach ramps.

Choose local plant species. Be sure to respect the planting and sowing periods (planting from November-March and sowing from September-March). Plan to inspect the materials and plants before proceeding.

For the "plantings", **remember the following:**

- Final acceptance is not accorded immediately following the "creation" process, rather it takes place after two growing seasons (on average 21 months after the planting services have been completed, marking the end of the creation work);

- between the time of the creation work and the final acceptance, hold points must be respected in order to proceed with the completion of the work and guarantee period (= consolidation work). The following is a reminder of the hold points (**in blue** in the summary *Table n°5, page 44*):

- Timeline:

1. Report on planting services being carried out
2. 1<sup>st</sup> growth report
3. Acceptance
4. 2<sup>nd</sup> growth report
5. Final report (= final acceptance)

Table n°5: Summary of the steps in a standard planting contract.

Creation work	Autumn	1st Partial Period	DP1-1 <b>PREPARATORY WORK</b>
	Winter		DP1-2 PLANTING WORK
	Spring		≤10 days report on planting services being carried out
Completion work	April	2nd Partial Period	<b>COMPLETION WORK</b>
	May		
	June		
	July		
	August		
	Sept.		
	Oct.		1 <sup>st</sup> growth report
	Nov.		Plant replacement, then <b>acceptance</b>
	Dec.		
Guarantee period	January	3rd Partial Period	<b>CONSOLIDATION WORK</b>
	February		
	March		
	April		
	May		
	June		
	July		
	August		
	Sept.		
	Oct.		2 <sup>nd</sup> growth report
	Nov.		Plant replacement, then <b>final report</b>
	Dec.		

The standard specifications for the plants are as follows: sowing density of 20 gr/m<sup>2</sup>, bushes and shrubs as branching seedlings (60 - 80cm) in C2 or C3 containers or bare-root or forest seedlings depending on the species, trees with a height of 175 - 200cm (saplings).

### Ponds

Plan for several ponds on the approach ramps, with a sufficient depth of 60 - 70cm (prevents soil from accumulating and conserves the water for a longer period of time) and gentle slopes. Circular shape with a minimum surface area of 5 m<sup>2</sup>.

A pond may be installed on the deck area as long as it does not adversely affect the deck's impermeability. Often the depth of the pond will not be able to exceed approximately 20cm and it will have limited wetness. However, a central pond can be used to cause animals to pass closer to the camera traps in avoiding the pond. It is therefore particularly advantageous for large structures.

In order to remain wet, the ponds are sealed by installing a puncture-resistant felt underlayment (300 g/m<sup>2</sup>) at the bottom of the pond + an EDPM-type liner (geomembrane, 1 mm thick), covered with topsoil (>10cm minimum). To maximize the ponds' natural water supply (rain and runoff), keep in mind the natural slope of the land or stretch the geomembrane liner further in order to use it for water collection (*see below*).

### Windrows

Windrows, which are frequently recommended, are composed of a continuous line of rocks (Ø60-80cm) with wood stumps and logs (Ø10cm minimum) fastened together with a steel cable (cable fed through holes pierced in the wood), at the ends, or with "Ursus" type fencing (maille > 10cm) covering the entire windrow and firmly attached to the ground. These measures should prevent theft and prevent the materials from being thrown onto the motorway.

The length of the windrow must enable it to be connected to the plants growing on both sides of the structure.

Wood that is rot-resistant should be used, such as chestnut, black locust, and oak (*see Photos n°38*). However, the stumps and logs will eventually decompose and disappear after several years, with plants taking their place. By then wildlife habits will be set, and replacing the wooden materials is unjustifiable.



Photos n°37: Construction of ponds. (© VINCI Autoroutes).



Photos n°38: Construction of windrows; note the cable feed on the photo on the left (left to right). (© VINCI Autoroutes).

### Preventing intrusions

Plan for a row of stone blocks with a  $\varnothing$  ranging from 80-120cm (approximately 1-2 t) to be arranged in a way that would prevent the passage of 4-wheel vehicles. Maintain a maximum 1m distance between each block (see Photo n°39). This row of blocks will be installed outside of the deck, on an approach ramp.



Photo n°39: **A line of blocks to prevent intrusions.**  
(© VINCI Autoroutes).

Wooden posts (autoclave,  $\varnothing$  120-200 mm) embedded vertically (1 m above ground) can also complement the installation of stone blocks and further reduce intrusions.

The use of metal fences made of series of horizontal bars and frames can also greatly deter vehicles from passing, while still allowing the passage of small and large animals.



Photo n°40: **Metal fence to prevent vehicle intrusions, yet allow the passage of fauna, on a wildlife overpass.** (© VINCI Autoroutes).



## EQUIPMENT FOR ECOLOGICAL MONITORING

The cameras are often installed on the wooden screens on the central section. However, it is advisable to also plan for cameras to be installed directly on the stone blocks of the windrow (installed by drilling and using pegs).

To install camera traps or SM2 recorders on an approach ramp, for example, it is possible to install two wooden posts (autoclave, Ø 120-200 mm) embedded vertically (2 m above ground) to be used as mounting poles.

### SPECIFIC CONDITIONS FOR PHOTOGRAPHICALLY MONITORING WILDLIFE OVERPASSES

Monitoring large animals with infrared camera traps is limited by the range of the camera's flash (visibility for night photographs) and by the sensor, both of which vary based on the model of the camera trap and the size of the animals detected. With a width of up to 8 m, a large animal passage can be monitored with only one camera. From a width of 8 to 15 m, two camera traps are required, one opposite the passage and one perpendicular to the centre line of the overpass. For greater widths, the addition of cameras in the central section requires mounting systems to be anticipated, such as sufficiently large stone blocks. The addition of a central pond is a possible technique and can effectively force animals to pass closer to the cameras.

The creation of a windrow adds a crossing corridor and implies the addition of a camera trap for small animals.

The roads, storage area, and planned worksite deck must be installed on top of geotextile with filler materials. The geotextile will facilitate the subsequent removal and the process of returning the site to its natural state.

The work deck will be fenced off (e.g. Héras type fencing). The geotextile must be attached to the fencing, at a height of approximately 1m, for the following reasons:

- to prevent materials from leaking into the natural environment;
- to avoid intrusions (risks of damage, CNPN-French Council for Nature Protection) caused by small animals entering the work zone.

It is possible to keep the cut wood in piles outside of the approach ramp area for windrow construction or storage (fauna shelters).

Pay special attention to each gate, ensuring there is no risk of wildlife entering the worksite, in order to prevent fauna from using the structure during the construction phase (see Photo n°41).



Photo n°41: Worksite gate with a sign indicating that it must be kept closed. (© VINCI Autoroutes).

## WORKSITE

The levelling work phase is the most environmentally disruptive. This phase should be scheduled to avoid the sensitive period of April-August (reproduction/rearing of young for most animal species).

Fauna-sensitive roads and land allowances must be in compliance with the environmental specifications **adopted at the time of the initial ecological state study** (respecting integration measures, markings, parking areas, protected areas, etc.), which should be outlined in the plan during the draft-design stage.

## REGULATORY GUIDELINES

Currently, excluding specific situations, the construction of a wildlife overpass requires a form to be completed on a "case-by-case" basis for the impact studies, Art. R122-2 (French Environmental Code, impact study reform, section n°7a -bridge under 100 m).

The "case-by-case" form will be part of the assessment of the impacts on the Natura 2000 sites, in compliance with the Decree of 9 April 2010 (assessment reform).

Before beginning any project, seek legal counsel to check if there have been any changes in legislation or case-law pertaining to the project.

## Methodology sheet 3

# CULVERT WALKWAY/CORBEL

Specifications from the feedback report on the design/construction of corbels and culvert walkways in hydraulic structures.

Corbels and culvert walkways depend on a structure's hydraulic capacity, and only a hydraulic study can reveal this dimension. Neglecting this preliminary step could hinder the fauna's use of the structure in the future (risk of structures being flooded too frequently). Furthermore, if the design adversely affects the structure's size (raising flood levels, failure to comply with the ordinances of the French Water Authority), the operator will be held liable for hydraulic and regulatory risks. Setting the norms in terms of water depth/inflow enables a visualisation of the options for the structure's altimeter setting. A setting below Q3\* is often too low, causing the corbels/culvert walkways to be flooded frequently. Often the layout of the motorways allow for a setting between Q3 and Q5, while ensuring that an air draught of 80 cm is maintained above the structure.

Ensuring that a fish-crossing capacity has been maintained represents an integral part of the study and is required by regulation (general provision of the ordinance of 28 November 2007). If the culvert walkway causes the water surface to rise by narrowing the width of the structure, this also will result in an increase in water velocity, which could potentially prevent fish from being able to cross.

Calculations must be made in order to ensure that the water draught and velocity, projected in a range between [QMNA<sub>5</sub>\* - 2.5 x Module] (corresponds to approximately 80% of the time), allow the fish species present in the watercourse to swim through the structure.

Many projects that initially plan for culvert walkways later opt for corbels due to factors involving hydraulic gauging and/or fish crossing. In other cases, the structure's design includes the addition of riffle constructions or deflectors, among other options intended for fish. However, corbels are often narrower than culvert walkways, and it is often more difficult to connect them to the banks upstream and downstream.

Therefore, the continuity objectives of the hydraulic structures must be considered for both terrestrial and aquatic crossings.



Photo n°42: Riffle constructions in a hydraulic structure with a corbel. (© Freyssinet)

## CONFIGURATIONS

	Corbel	Culvert walkway
<b>Advantages</b>	<ul style="list-style-type: none"> <li>• less of an impact on the hydraulic capacity of the structure than a culvert walkway;</li> <li>• simpler argumentation presented to the French Water Authority;</li> <li>• prefabrication optimizes the “feet in the water” construction period.</li> </ul>	<ul style="list-style-type: none"> <li>• installation aligned with animals’ natural pathway;</li> <li>• self-cleaning aspect</li> <li>• can be installed in metal pipe culverts.</li> </ul>
<b>Disadvantages</b>	<ul style="list-style-type: none"> <li>• cannot be installed in metal pipe culverts;</li> <li>• difficult connections with banks;</li> <li>• generally has less of a self-cleaning feature (cleaned during flooding), due to higher position than a culvert walkway.</li> </ul>	<ul style="list-style-type: none"> <li>• has a greater impact on the hydraulic structure’s discharge capacity than a corbel;</li> <li>• administrative framework with the French Water Authority potentially more complex;</li> <li>• generally a longer construction period.</li> </ul>

Check if any renovations are planned for the hydraulic structure (relining of pipe culverts); in which case, take this into account for the dimensions.

The width to aim for is between 50cm (minimum) and 70cm (maximum), depending on the type of hydraulic structure.

Special attention must be paid to how the installation is set into the hydraulic structure, based on the structure’s configuration. This requires analysis, because the setting is not necessarily parallel with the bottom of the pipe culvert (submersion risk partial immersion risks for the Q limit values in the event of a break in slope in the hydraulic structure and/or causing eddies downstream) nor is the setting necessarily levelled (z-factor that can be restrictive for the air draught).

For corbels, design solutions must be chosen (polymer concrete, GRP\*, Ultra High Performance Fibre Reinforced Concrete (UHPFRC)) to optimize installation times.

Wooden solutions should be avoided (theft, damage, limited durability).

Strength calculations for the corbel must account for the potential weight of a human crossing it (inside and outside the hydraulic structure), because the structure is always accessible (fisherman, curious passers-by).

**Special attention must be paid to the connections with the banks, in order to ensure the following:**

- that no “hard points” are created for drainage;
- if possible, wildlife should be able to access the structure from the mainstream base and the top of the bank.



Photos n°43: Corbel made of polymer concrete, completed corbel in the hydraulic structure and connection that provides wildlife access from the base and the top of the bank, and does not create a hard spot for drainage (left to right).  
 (© VINCI Autoroutes).



Photos n°44: Formwork for a double culvert walkway (left) and the completed culvert walkway inside the hydraulic structure (right). (© VINCI Autoroutes).

### SIZE CALCULATIONS

The request submitted to the French Water Authority must demonstrate the following:

- that it will not adversely affect the waterline and the structure's hydraulic capacity;
- that it will not have any negative effect on the water level and velocity related to fish crossing (general provision ordinance) and the indication of the potential classification on list 1 and/or 2 (R214-17 French Environmental Code).

The installation must effectively allow fish to cross the structure 80% du temps. Water levels and velocity must be within the flow range of  $[QMNA_5^* - 2.5 \times Module^2]$ , allowing the fish species present in the watercourse to cross the structure.

This demonstration is valid for both a corbel and a culvert walkway. In general, the corbel has less of an impact, because it does not affect the water velocity of the water flow below its setting (due to it being out of the water). The culvert walkway always impacts the water level and velocity (a demonstration of the velocity field can be helpful).

Consequently, a project to modify a hydraulic structure for terrestrial fauna very often will add rough surfaces or other deflectors (adapted to the capacity of the hydraulic structure) which reduce the water velocity and maintain the levels compatible with the swimming capacities of the fish present in the watercourse.

If the structure did not previously enable fish crossings before the modification, at the time of the project rough surfaces or other adapted measures should be added, provided that they do not adversely affect the structure's hydraulic capacity.

In the event that sediments must be moved for worksite purposes (dredging then returning them to the hydraulic structure, or need for an external supply), the safety of these sediments must be proven via a sediment analysis (the "S1" analysis in accordance with order of 09 August 2006).

### SPECIFIC CONDITIONS FOR PHOTOGRAPHICALLY MONITORING HYDRAULIC STRUCTURES

The monitoring constraints for hydraulic structures vary greatly (dimensions, clear width, materials used for the walls, the structure's access to water, etc.). In general, the monitoring must therefore be dealt with on a case by case basis. As is the case with wildlife tunnels, it is best to install the camera 5 metres inside the structure, facing the longest side. In order to do this, several mounting supports are possible for hanging the camera (mounting angle, articulating arm mount) so as to not prevent animals from passing through a clear width that is often limited (50 cm), and to maintain enough distance so that the crossings may be detected.

<sup>1</sup> Average interannual flow rate

## FENCES

Unlike wildlife underpasses and overpasses, for which fences play an important role in guiding wildlife, particularly for herpetofauna, hydraulic structures are rarely connected to fences. The guiding aspect is not as prominent and amphibian issues are not targeted.

Therefore, a single layer of small-mesh fencing with apertures of 25 x 13 mm or 25 x 25 mm (Ø of wire: 1.8mm) semi-buried over 30cm in the ground, with a minimum of requirement of 70cm above ground (see Figure n°8).

Reinforcement should be added to approximately 150 lm on both sides of the hydraulic structure in both directions, covering a total distance of approximately 600 lm.

In most cases, replacing and repositioning the motorway fencing is unnecessary for this type of structure (except if damage does not allow it to be reinforced). To be determined beforehand during the draft-design stage.

## EQUIPMENT FOR ECOLOGICAL MONITORING

Plan to have an L-shaped bar made of two mounting angles attached to the walls of the hydraulic structure 80cm above the corbel or culvert walkway.



Photo n°45: An L-shaped mounting angle installed for ecological monitoring after the structure modification. (© VINCI Autoroutes).

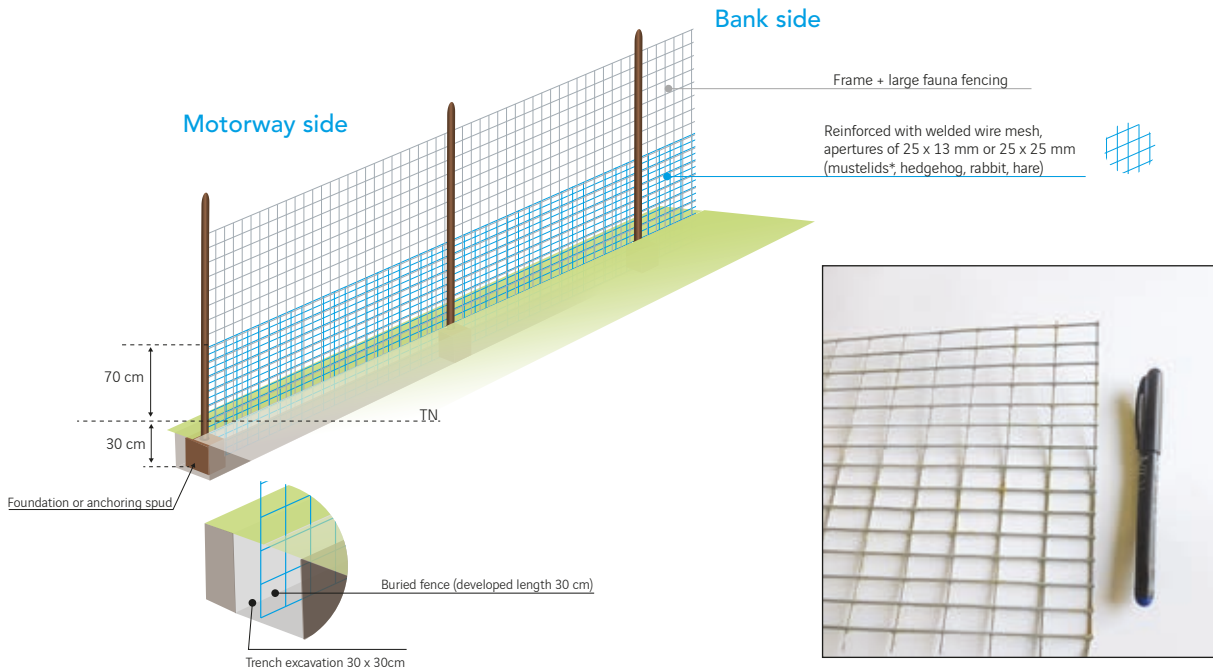

Figure n°8: Mesh with 25 x 13mm apertures and reinforcement diagram (from left to right).

## WORKSITE

Although it is limited to low water periods, the construction timetable (see competent Departmental Territorial Directorate (DDT)) will vary based on the ecological issues specific to the site (e.g. if Otter/Mink issues are a priority, it may be advisable to only work beginning in September, if it is White-clawed crayfish issues, construction can be delayed until October according to their sensitivity).

Required diversion of watercourses will be conducted using culverts with cofferdams and mandatory electrofishing for safeguard purposes beforehand (see Photos n°46).

Road and land allowances must be in compliance with the environmental specifications recorded in the submitted project forms (respecting integration measures, markings, parking areas, protected areas, etc.), which should be determined during the draft-design stage.

The fauna-sensitive roads, storage area, and planned worksite deck must be installed on top of geotextile with filler materials. The geotextile will facilitate the subsequent removal and the process of returning the site to its natural state.

The work deck will be fenced off (e.g. Héras type fencing). The geotextile must be attached to the fencing, at a height of approximately 1m, for the following reasons:

- to prevent materials from leaking into the natural environment;
- to avoid intrusions (risks of damage, CNPN-French Council for Nature Protection) caused by small animals entering the work zone.

A pollution prevention plan is mandatory, including suitable filtration measures and anti-pollution precautions (see Photos n°47).



Photos n°47: Anti-pollution kit, generator on a double bottom tank with a waterproof tarpaulin surrounding it (top to bottom). (© VINCI Autoroutes).



Photos n°46: Diversion with culverts and cofferdams (note the realisation of the connection with the bank on the picture), electrofishing carried out before hand by a French fishing federation, FDPPMA (left to right). (© VINCI Autoroutes).

Be careful to avoid any headward erosion of the banks and the bed, particularly caused by the water outlet downstream from the deviation culvert. It is advisable to implement an anti-erosion measure or other system at this water outlet in order to preserve the riverbed (see Photo n°48).



Photo n°48: **Anti-erosion covering at deviation culvert outlet.**  
(© VINCI Autoroutes).

## REGULATORY GUIDELINES

Currently, excluding specific situations, the construction of a corbel is subject to the administrative framework of the French Water Authority (generally via a declaration or providing information for authorised structures, under R214-18 and R214-51 of the French Environmental Code).

Since it is under the administrative authority of the French Water Authority, the file necessarily assesses the impacts on the Natura 2000 sites, in compliance with the Decree of 9 April 2010 (assessment reform).

Before beginning any project, seek legal counsel to check if there have been any changes in legislation or case-law pertaining to the project.





## GLOSSARY

**Anurans:** (literally “without a tail”), amphibians that no longer have a tail in the adult form and have hind legs adapted for jumping (frogs, toads).

**CARMEN:** Cartographie du Ministère de l’Environnement (Cartography of the French Ministry of the Environment).

**Corbel:** construction attached to the inner walls of a structure (generally hydraulic) that enables wildlife to cross on dry ground.

**Culvert walkway:** single or double step structure, resting on the base of a hydraulic structure, set laterally, enabling wildlife to cross on dry ground.

**DDT:** Direction Départementale des Territoires. (Departmental Territorial Directorate)

**Ectotherm:** ectotherms are organisms whose body temperature is the same as their external environment.

**ELS:** “États Limites de Service en matière d’ouvrages d’art”: Serviceability limit states for engineering works.

**Eurocodes:** Eurocodes are a set of 58 European standards, applied voluntarily, that standardise the calculation methods used to inspect the stability and size calculations of the different elements that make up buildings or civil engineering structures, regardless of the type of structure or material.

**Grey literature:** this term refers to documents published outside of commercial channels by public or private organizations: study reports, conference proceedings, theses, etc.

**GRP:** Glass-Reinforced Polyester.

**Large fauna:** red deer, roe deer, wild boar, chamois, wolf, lynx...

**Medium fauna:** mustelids (beech marten, pine marten, polecat, genet, badger, otter, European mink) fox, wildcat, European rabbit, hare...

**Mustelids:** carnivorous mammal family of animals of small or medium size, with long tails, short legs, and long, narrow bodies (weasel, stoat, pine marten, beech marten, polecat, mink, otter, badger...).

**Nidifugous:** species in which the members are able to walk almost from the time of birth.

**ONEMA:** Office National de l’Eau et des Milieux Aquatiques, French National Office for Water and Aquatic Environments.

**“Open-ended” technique:** a semi-manual digging method in which operators dig in a forward motion.

**PLU:** Plan Local d’Urbanisme, Local urban planning plan.

**PLUi:** Plan Local d’Urbanisme intercommunal, Local Intercommunal Urban Planning.

**PVA:** Paquet Vert Autoroutier, Green Motorway Package.

**Q3:** flood discharge (in m<sup>3</sup>/s) for a return period of 3 years.

**QMNAS:** minimum monthly discharge value occurring approximately once every 5 years.

**SCoT:** Schéma de Cohérence Territoriale, Territorial Consistency Plan.

**Small Fauna:** amphibians, reptiles, small mustelids (weasel, mink) small mammals (field mouse, vole, shrew...) European hedgehog...

**SRCE (schéma régional de cohérence écologique):** plan for territorial spatial planning, which led to the creation of Green and Blue networks.

**Taxon:** refers to a classification of living organisms that are grouped together based on common characteristics due to their evolutionary relationships.

**Urodélans:** (literally means “visible tail”), amphibian with a tail in the adult form that walks on 4 legs (e.g. newt).

**Wildlife overpass:** overpass that is wide enough and is designed for all wildlife (small, medium, large) by creating diverse habitats (sowing, planting, ponds, windrows, hiding-places...) to allow the maximum amount of animal species to cross over the transport infrastructure.

**Wildlife underpass:** small and medium-sized underpasses (up to 2m in width), which allow fauna to pass under the transport infrastructure (e.g. dry pipe culvert with soil substrate).



## REFERENCE DOCUMENTS

- **Technical guide** – *Passages pour la grande faune, SETRA, December 1993.*
- **Technical guide** – *Aménagements et mesures pour la petite faune, SETRA, August 2005.*
- **Feedback report** – *Routes et passages à faunes, 40 ans d'évolution, SETRA, August 2006.*
- **COST 341 Report** – *Habitat fragmentation due to Transportation Infrastructure, SETRA, September 2007.*
- **Information Brief** – *Clôture routière et faune, SETRA, 2008 (being updated).*
- **COMOP TVB Guide 3** – *Prise en compte des orientations nationales pour la préservation et la remise en bon état des continuités écologiques par les grandes infrastructures linéaires de l'État et de ses établissements publics – 3<sup>e</sup> document en appui à la mise en œuvre de la Trame verte et bleue en France: Allag-Dhuisme F., Barthod C., Bielsa S., Brouard-Masson J., Graffin V., Vanpeene S., Chamouton S., Dessarps P-M. Orsini A., 2010.*
- **Information Brief n°96** – *« Petits ouvrages hydrauliques et continuités écologiques – Cas de la faune piscicole », SETRA, December 2013.*
- **Information on Ecological Continuity - ICE** – *Évaluer le franchissement des obstacles par les poissons. Principes et méthodes, ONEMA, July 2014.*
- **Scientific article published in la Revue d'Écologie** – *« Fagart S., Heurtebise C., Quaintenne G., Jourde P., Micol T. (2016) - Fréquentation de buses dédiées aux passages de la petite et moyenne faune sous 2 autoroutes de l'ouest de la France. Bilan des deux premières années de suivis par pièges photographiques: La Terre et la Vie, Vol. 71 (1): 82-98 ».*
- **Technical Guide** – *Chiroptères et infrastructures de transport, CEREMA, April 2016.*
- **Feedback report on the wildlife structures and monitoring in the VINCI Autoroutes network** – *VINCI Autoroutes, LPO France, CEREMA, 2016.*
- **Wildlife surveys following the construction of modified culverts - Developing and providing a vibration-trap** – *FAGART, S. & HEURTEBISE C. (2016). IENE, 2016.*
- **Use by large mammals of wildlife crossing structure on an overpass in western France. Results of the first three years of camera-trap surveys** – *BOUTON, G., DAVID, M., HEURTEBISE, C. (2016). IENE, 2016.*





**VINCI Autoroutes**

Technical Infrastructure Management

74, allée de Beauport

84278 Vedène cedex

Tel.: +33 (0)4 90 32 73 54

Fax: +33 (0)4 90 32 91 08

